



T H E

4

CONVERTIBLE

THE BMW 4 SERIES CONVERTIBLE.



INNOVATION AND TECHNOLOGY.



18 Powertrain and Suspension



20 Driver assistance
21 Safety



22 Connectivity and infotainment
23 Comfort and functionality

EQUIPMENT.



24 Models and Lines



32 Additional equipment

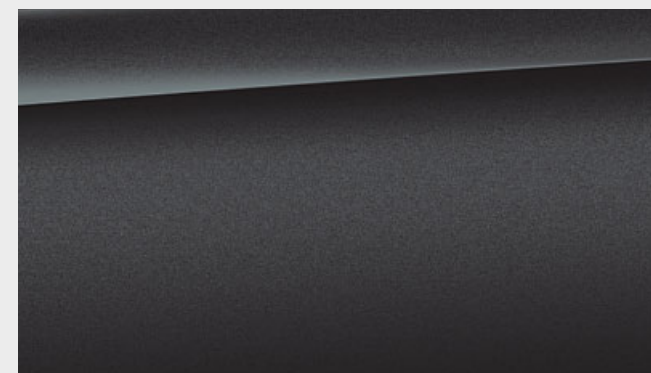

36 Exterior colours

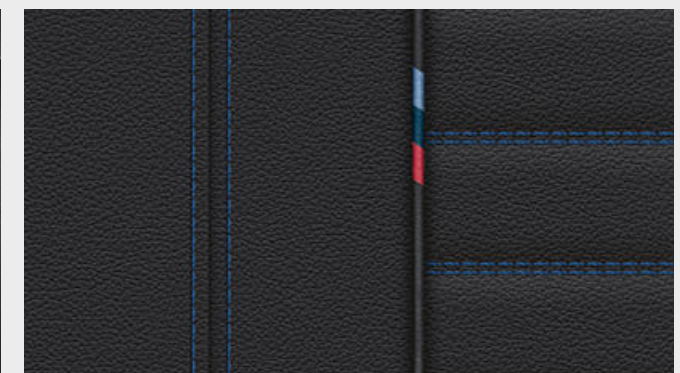

38 Interior colours



ALL BMW MODELS IN ONE APP.

DOWNLOAD THE **BMW Products** APP NOW AND
DISCOVER THE PLEASURE OF DRIVING.



40 Wheels and tyres



41 Original BMW Accessories and
BMW M Performance Parts

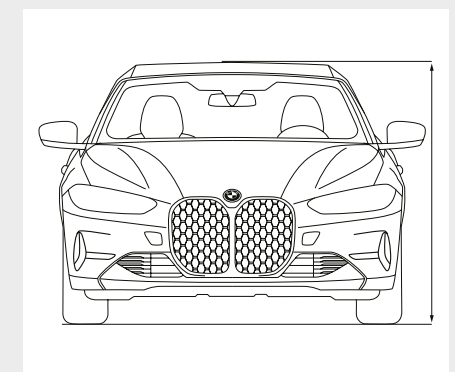

42 Technical data

A STATEMENT IN STYLE.





FOLLOWING TRENDS IS GOOD.
SETTING THEM IS BETTER.

REDISCOVER YOURSELF.
IN SECONDS.



TRUE ELEGANCE IS BORN WHERE
DYNAMICS AND DESIGN UNITE.







TRUE CHARACTER
ACCEPTS NO LIMITS.

ALWAYS UP FRONT.

THE BMW 4 SERIES CONVERTIBLE.



■ Standard equipment □ Optional equipment



ENGINE HIGHLIGHTS OF THE BMW 4 SERIES CONVERTIBLE.

M440i xDrive³ with mild hybrid technology

BMW TwinPower Turbo 6-cylinder petrol engine with 275 kW (374 hp) and 500 Nm torque (plus 8 kW (11 hp) with mild hybrid technology)
Acceleration 0–100 km/h: 4.9 s
Top speed: 250 km/h¹
Combined consumption²: 7.8–8.4 l/100 km
Combined CO₂ emissions²: 177–192 g/km

430i

BMW TwinPower Turbo 4-cylinder petrol engine with 190 kW (258 hp) and 400 Nm torque
Acceleration 0–100 km/h: 6.2 s
Top speed: 250 km/h¹
Combined consumption²: –⁴
Combined CO₂ emissions²: –⁴

■ The intelligent **BMW xDrive all-wheel drive system*** smoothly and variably distributes drive power to the front and rear wheels for added traction, driving dynamics and safety in every driving situation. For even better agility, the electronically controlled power distribution for instance counterbalances oversteer or understeer on bends.

□ The **variable sport steering*** with Servotronic creates a direct and agile steering response and ensures that less physical effort is required to turn the wheel. It reacts to the angle of the steering wheel with varying steering ratios. This improves handling when driving more dynamically and reduces the effort needed to steer when parking and turning.

□ The **Adaptive M suspension** can be electrically adjusted at any time to suit the road and driving conditions. You can also adjust the suspension characteristics via the Driving Experience Control to enable your preferred driving style at the time – from comfortable to extremely athletic with markedly agile handling.

M SPORT BRAKES

□ The M Sport brake⁵ has four-piston fixed calipers at the front and single-piston floating calipers at the rear in Blue metallic with the M logo and features larger brake discs to ensure an outstanding braking performance. Adapted to the vehicle's very high dynamic potential, it also allows an exceptional athletic driving style and excellent braking on wet surfaces.

MILD HYBRID TECHNOLOGY

□ Mild hybrid technology* is used to recover braking energy and supports the combustion engine during acceleration with electric power. This reduces fuel consumption and emissions while giving you a dynamic advantage. The mild hybrid technology also makes the Automatic Start/Stop function much faster and much more comfortable.

8-SPEED STEPTRONIC SPORT TRANSMISSION

□ The 8-speed Steptronic Sport transmission* offers incredibly sporty gear changes. Whether automatic or manual using the selector lever or gearshift paddles – for comfortable coasting or incredibly dynamic driving. In SPORT mode and with the selector lever in the left-hand S/M position, the gear shifts are configured for the maximum performance.

M SPORT DIFFERENTIAL

□ The M sport differential* optimises traction and driving stability when driving dynamically or on different road surfaces.

SERVOTRONIC

■ Servotronic optimally adjusts the power steering to suit the speed and delivers a direct and precise steering response.

DRIVING EXPERIENCE CONTROL

■ The Driving Experience Control features various different modes, so you can choose between a comfortable, particularly efficient or superbly athletic drive.



¹ Electronically limited.

² Official data for fuel consumption and CO₂ emissions was determined in accordance with the prescribed measuring procedure and corresponds to European Regulation (EC) 715/2007 in the applicable version. For ranges, data determined as per WLTP takes

into account any optional equipment (available on the German market in this case). For vehicles that have been newly type approved since 1 January 2021, only the official data according to WLTP exists. For more information about NEDC and WLTP measuring procedures visit www.bmw.com/wltp

³ This engine version is not available in all countries. For further information, please contact your local BMW Partner.

⁴ Provisional figures; any missing figures were unavailable at the time of publication.

⁵ Only available for M440i xDrive and M Sport package.

*The availability of some equipment features and functions depends on engine variants or additional options. The market and production availability may vary. You can find detailed information about terms, standard and optional equipment at www.bmw.com or at your BMW Partner.

DRIVER ASSISTANCE.

□ **Driving Assistant Professional¹*** offers optimum comfort and safety during critical or monotonous traffic situations. Apart from the contents of the Driving Assistant, it also includes Steering and Lane Control Assistant with extended functions, Emergency Stop Assistant and Lane Keeping Assistant with active side collision protection.

□ **Active Cruise Control with Stop&Go function*** automatically maintains a pre-defined distance from the vehicle ahead, and controls speed down to a standstill.

□ The **Steering and Lane Control Assistant with extended functions*** can be activated to support you in monotonous traffic situations. It helps you to keep the vehicle in the centre of its lane, assists you in narrow places and, with active route guidance, makes navigation on motorways easier.

□ The **Assisted View*** provides real-time information on the vehicle surroundings collected by various assistance systems. Thanks to an animated 3D display in the instrument cluster, you can clearly see how your vehicle perceives the current traffic situation and thus understand how the systems work.

□ **Parking Assistant Plus²*** makes parking and manoeuvring the vehicle easier. It features among others the Surround View system including Top View, Panorama View, Remote 3D View, as well as a lateral parking aid, the emergency braking function Active Park Distance Control, Parking Assistant with longitudinal and lateral guidance and Reversing Assistant.

□ The **Reversing Assistant*** stores the last 50 m of the driven path in forward travel up to 35 km/h, so that it can be retracted if required. You are relieved of the steering work and can concentrate on monitoring the vehicle environment.



SAFETY.

■ Standard equipment □ Optional equipment



□ In the event of a medical emergency, the **Emergency Stop Assistant*** can drive the vehicle for a short period of time and bring it to a standstill.

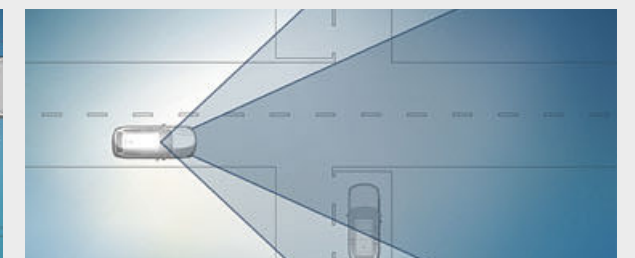

□ The **junction warning*** with brake intervention detects traffic lights, traffic signs and vehicles crossing and helps to avoid accidents.

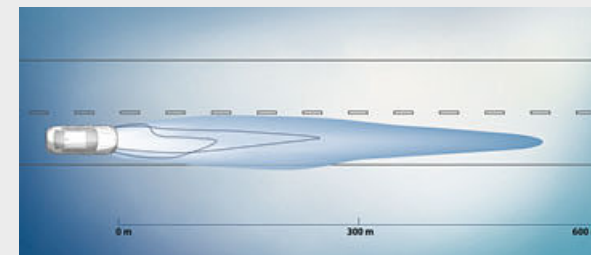

□ The Adaptive **BMW Laserlight*** extends the maximum illumination range in high-beam mode to up to 550 m.

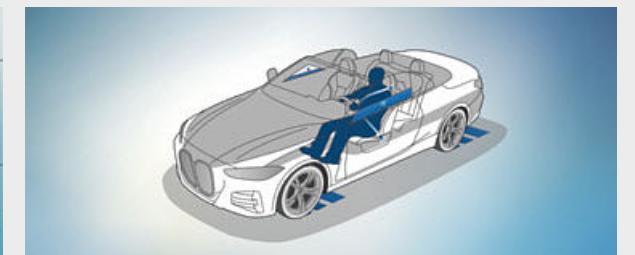

□ The preventive occupant protection **Active Protection** takes precautions in critical situations.

¹ Function may be limited in darkness, fog or bright glare.

² The driver is responsible for constantly monitoring the automated parking procedure in accordance with local road laws.

*The availability of some equipment features and functions depends on engine variants or additional options. The market and production availability may vary. You can find detailed information about terms, standard and optional equipment at www.bmw.com or at your BMW Partner.

CONNECTIVITY AND INFOTAINMENT.

BMW ConnectedDrive
So connected, you're free.



CONNECTED PACKAGE PROFESSIONAL

□ Concierge Service, Remote Services, smartphone integration incl. Apple CarPlay and Android Auto, In-Car Experiences, Connected Music or BMW Maps with Connected Navigation and Connected Parking? Get them all! With the Connected Package Professional*, you can get these BMW ConnectedDrive services as well as BMW Music to test free of charge.

SMARTPHONE INTEGRATION

□ Why go without the features of your smartphone in your BMW when you can continue operating it as usual? With smartphone integration¹*, your vehicle supports Apple CarPlay and Android Auto by means of a wireless connection between your smartphone and the vehicle. This allows you to conveniently use familiar functions and various apps in the vehicle.

BMW MAPS – CONNECTED NAVIGATION

□ BMW Maps – Connected Navigation* impresses with high accuracy of the predicted arrival time, extremely fast route calculation and simplified destination entry. This is possible through free text input. The cloud-based dynamic route calculation immediately adapts the route recommendation to any changes in the traffic situation.

REAL TIME TRAFFIC INFORMATION

□ Stuck in rush hour after work or wasting valuable holiday time in traffic jams? Such situations can easily be avoided with Real Time Traffic Information*. It monitors the current traffic situation virtually in real-time, suggesting alternative routes well in advance and bringing you to your destination as quickly as possible.

BMW INTELLIGENT PERSONAL ASSISTANT

□ The BMW Intelligent Personal Assistant* is your personal vehicle expert. It allows you to operate numerous vehicle functions using natural language.

BMW OPERATING SYSTEM 7

□ The innovative operating concept of the BMW Operating System 7* enables even easier operation of vehicle functions via e.g. speech, touch screen and iDrive Controller.

¹ Smartphone integration is permanently available in the vehicle. It includes Apple CarPlay and Android Auto. Due to possible future technical developments (e.g. of mobile phones), the usability of the Apple CarPlay or Google Android Auto service cannot be guaranteed permanently. CarPlay is a trademark of Apple Inc. Android Auto is a trademark of Google LLC.

COMFORT AND FUNCTIONALITY.

■ Standard equipment □ Optional equipment

■ The **Sport seats for driver and front passenger** provide optimum lateral support with their raised side bolsters and manually adjustable thigh support. The fore-and-aft position, seat height and seat angle can be adjusted electrically.

□ Even before the engine has reached its running temperature, the **seat heating for driver and front passenger** provides pleasant warmth, adjustable in three levels. The heat elements warm the surface of the seat, the side bolsters, and the entire contact surface of the backrest.

□ The **Air collar** ensures comfort when driving by pleasantly providing warmth for the head and shoulders. When the roof is open, the warming system integrated into the front seat headrests is automatically regulated based on the speed and outside temperature. Three different temperature levels can also be personally selected.

□ In warm weather, the **front active seat ventilation*** provides a cool and pleasant seat temperature, resulting in a more comfortable driving experience. Air vents in the seat surfaces and backrests blow air through the perforated seat covers. The intensity of the airflow is selected from three available settings.

□ **Ambient light**, including Ambient contour lighting in the doors, creates a relaxed, cosy lighting atmosphere in the interior. The eleven dimmable lighting designs also include a dynamic function in four applications. The Welcome Light Carpet illuminates the area in front of the vehicle doors when entering and exiting.



*The availability of some equipment features and functions depends on engine variants or additional options. The market and production availability may vary. You can find detailed information about terms, standard and optional equipment at www.bmw.com or at your BMW Partner.

Some ConnectedDrive Services may differ between countries. Please consult your local BMW partner for more information.

Discover even more with the new BMW Brochures app. Available now, for your smartphone and tablet.

■ Standard equipment □ Optional equipment



■ The black Sport leather steering wheel with four spokes features a Pearl Chrome decorative trim. A thick rim and contoured thumb rests provide an exceptionally pleasant, high-grip feel.

Selected base model equipment features:

- 17" light alloy wheels V-spoke style 778
- Cloth/Sensatec combination | Black
- Interior trim finishers Black high-gloss
- BMW Live Cockpit, 8.8" Control Display with touch function, analogue instrument cluster with 5.1" display
- Sport leather steering wheel
- Multifunction buttons on the steering wheel
- 1-zone automatic air conditioning
- Steptronic transmission
- Seat adjustment, electric, with memory
- Electrical convertible top
- LED headlights
- Through-loading system



■ The Sport seats for driver and front passenger provide optimum lateral support with their raised side bolsters and manually adjustable thigh support. The fore-and-aft position, seat height and seat angle can be adjusted electrically.



■ 17" light alloy wheels V-spoke style 778 Reflex Silver, wheel size 7.5J x 17 with 225/50 R17 tyres.



□ 19" light alloy wheels Y-spoke style 783 Bicolour Jet Black with mixed tyres and run-flat tyres, gloss-lathed, wheel size front 8J x 19 with 225/40 R19 tyres, wheel size rear 8.5J x 19 with 255/35 R19 tyres.

M SPORT PACKAGE.

Discover even more with the new BMW Brochures app. Available now, for your smartphone and tablet.



■ Standard equipment □ Optional equipment



■ The M Leather steering wheel including multifunction buttons, an M badge and an integrated driver-side airbag is featured in three-spoke design. With a steering wheel rim in leather 'Walknappa' Black with black stitching and contoured thumb rests, it provides a direct, athletic steering experience.



■ The Sport seats for driver and front passenger provide optimum lateral support with their raised side bolsters and manually adjustable thigh support. The fore-and-aft position, seat height and seat angle can be adjusted electrically.

M Sport package exterior equipment:

- M Aerodynamics package with front apron, side sills and rear apron in body colour with two-piece diffuser insert in Dark Shadow metallic and Black high-gloss
- LED fog lights
- 18" M light alloy wheels Double-spoke style 848 M Bicolour Jet Black with mixed tyres; other wheels available
- M Sport suspension incl. Variable sport steering; other suspensions available
- M high-gloss Shadow Line, alternatively BMW Individual Exterior Line Aluminium satinised
- M designation on the sides
- Tailpipe trims in Chrome high-gloss, alternatively in Black high-gloss*
- Exclusive M Portimao Blue metallic exterior colour; other exterior colours available

M Sport package interior equipment:

- M entry sills
- M driver footrest* and M pedals
- Sport seats for the driver and front passenger in 'Vernasca' Black leather with Blue contrast stitching; other upholsteries available
- M leather steering wheel
- Vehicle key with exclusive M logo
- M interior trim finishers in Aluminium Tetragon; other trims available



■ 18" M light alloy wheels Double-spoke style 848 M Bicolour Jet Black with mixed tyres, gloss-lathed, wheel size front 7.5J x 18 with 225/45 R18 tyres, wheel size rear 8.5J x 18 with 255/40 R18 tyres.



□ 19" M light alloy wheels Double-spoke style 791 M Jet Black uni with mixed tyres and run-flat tyres, wheel size front 8J x 19 with 225/40 R19 tyres, wheel size rear 8.5J x 19 with 255/35 R19 tyres.

*The availability of some equipment features and functions depends on engine variants or additional options. The market and production availability may vary. You can find

detailed information about terms, standard and optional equipment at www.bmw.com or at your BMW Partner.

BMW M440i xDRIVE CONVERTIBLE.

Design, drive, driving dynamics: In each discipline, the BMW M440i xDrive Convertible goes its own way and confidently takes the lead. The 275 kW (374 hp) of the M TwinPower Turbo 6-cylinder petrol engine with xDrive with emphasis on the rear wheels is translated 1:1 into euphoric driving pleasure thanks to the specially tuned M Sport suspension and the M Sport differential, which can be kept under absolute control thanks to the powerful M Sport brakes. But, even visually, the BMW M440i xDrive Convertible leaves everyday life behind: From optional 19" M light alloy wheels with performance tyres to eye-catching details such as the M door sill finisher or an M440i model designation at the rear – this exceptional athlete fascinates anew at every encounter.

■ Standard equipment □ Optional equipment



□ A sight magnet from the side view: 19" M light alloy wheels Double-spoke style 791 M with performance tyres and mixed tyres create an exclusive and sporty appearance.



■ A strong welcome: When the door opens, the M door sill finisher at the front becomes visible and creates an adrenaline-charged motorsport atmosphere as soon as you get in.



■ The model badge of the BMW M440i xDrive Convertible is in the signature colour Cerium Grey and sits eye-catchingly on the right-hand side of the vehicle's tailgate.



□ In the cockpit, the interaction of numerous details, such as the specific display in the instrument cluster and the BMW Head-Up Display¹*, an M leather steering wheel or the consistent driver orientation, creates the ideal conditions for an unforgettable driving experience.

¹ The information in the BMW Head-Up Display is not fully visible when viewed through polarised sunglasses. Content shown will depend on the equipment options chosen. Further optional equipment is required to display specific items.

*The availability of some equipment features and functions depends on engine variants or additional options. The market and production availability may vary. You can find detailed information about terms, standard and optional equipment at www.bmw.com or at your BMW Partner.

BMW INDIVIDUAL.

THE EXPRESSION OF PERSONALITY.



With its silky shimmer, the BMW Individual Frozen Deep Grey metallic paint finish impressively emphasises the sporting elegance of the BMW 4 Series Convertible: This is only made possible by special pigmentation within the multi-layer coating process. A metallic paint finish forms the base. Then a perfectly matched, matt clear coat provides the special finish. This creates a silky-matt surface without looking dull.



The Ivory White colour is a particularly impressive way to show off the exquisite, perfectly crafted material of the BMW Individual full leather trim 'Merino'.



The BMW Individual interior trim finishers Aluminium fabric high-gloss set fine highlights in the interior, creating a sporty and exclusive atmosphere.

If someone decides, then you: BMW Individual offers you all the options to customise the BMW 4 Series Convertible according to your wishes, with the degree of customisation entirely up to you. Add your personal driving experience to the typical BMW driving pleasure. Choose what suits you the most from particularly high-quality equipment options: Exclusive BMW Individual paintwork that show style and confidence. Soft, expansive leather trims and interior trim finishers made of fine woods, which turn the interior into your personal comfort zone. Or go your very own way, only following your ideas – BMW Individual ensures that they become an automotive reality.

ADDITIONAL EQUIPMENT.

Discover even more with the new BMW Brochures app. Available now, for your smartphone and tablet.

■ Standard equipment □ Optional equipment



■ The convertible top considerably reduces the noise level in the interior and also provides outstanding insulation against the cold. No matter whether seen from the inside or outside, its high-quality look is a real headturner. The electric convertible top can even be opened or closed fully automatically at speeds of up to 50 km/h.



□ The M high-gloss Shadow Line includes numerous equipment features in Black high-gloss. These include the window cavity seals including the softtop finishers, the exterior mirror frame and the mirror triangle and blade.



□ The large full-colour BMW Head-Up Display¹* projects information relevant to the journey directly into your field of vision, thereby allowing you to fully concentrate on driving. Information such as the current speed, navigation directions, Speed Limit Info including no-overtaking indicator, along with telephone and entertainment lists are displayed, depending on the equipment.



□ The Comfort Access²* makes it possible to open all of the vehicle doors and the luggage compartment, without using the key. When approaching, the welcome greeting is activated even before the doors unlock automatically.



□ M leather steering wheel including multifunction buttons, steering wheel rim in leather 'Walknappa' Black with contoured thumb rests.



□ The M seat belts³ with belt tensioner and belt force limiter boast an exquisite stitched highlight in the classic M colours.



□ The M Sport package Pro⁴ adds the finishing touches to the vehicle in terms of sportiness. In the exterior, among other things, the M lights Shadow Line and the 1" larger light-alloy wheels compared to the M Sport package ensure a sharper appearance. The Steptronic Sport transmission, the Sprint function and a sporty sound setting in the interior contribute to an exciting driving experience.



□ The M Carbon exterior package³ underlines the athletic demands of the vehicle. Side spoiler elements in the front bumper and exterior mirror caps are made of carbon-fibre reinforced plastic (CFRP). The package is rounded off by a diffuser insert at the rear.



□ The wind deflector provides you and your front passenger with effective protection from draughts at neck and shoulder-height, even when travelling at high speeds. When it is not needed, the collapsible sides can simply be folded together for easy and compact storage.



□ The M Sport brake has four-piston fixed calipers at the front and single-piston floating calipers at the rear in Red high-gloss³ with M lettering and features larger brake discs to ensure an outstanding braking performance. Adapted to the vehicle's very high dynamic potential, it also allows an exceptional athletic driving style and excellent braking on wet surfaces.



□ The mirror caps are painted in Black high-gloss* instead of the body colour. They emphasise the vehicle's athletic look and create an individual appearance.

¹ The information in the BMW Head-Up Display is not fully visible when viewed through polarised sunglasses. Content shown will depend on the equipment options chosen. Further optional equipment is required to display specific items.

² Prerequisite is a BMW ConnectedDrive account and a compatible smartphone. For customers with a non-compatible smartphone, a high-quality Key Card is provided.

³ Only available for M440i xDrive and M Sport package.

⁴ Only available in conjunction with M Sport package.

* The availability of some equipment features and functions depends on engine variants or additional options. The market and production availability may vary. You can find

detailed information about terms, standard and optional equipment at www.bmw.com or at your BMW Partner.

ADDITIONAL EQUIPMENT.

Discover even more with the new BMW Brochures app. Available now, for your smartphone and tablet.

■ Standard equipment □ Optional equipment



□ The BMW Live Cockpit Professional* with navigation function includes two high-quality displays consisting of a high-resolution 10.25" Control Display that can be operated by touch and a fully digital 12.3" instrument display. The BMW Operating System 7 can also be operated via the iDrive Touch Controller.



□ At the touch of a button, the steering wheel heating* quickly warms up the steering wheel rim to a pleasant temperature. The steering wheel gives you a pleasant warm feeling even when it's cold outside, allowing you to comfortably and safely steer the vehicle without the encumbrance of gloves – a great boost in comfort, especially during the winter months. The activation button is easily accessible directly on the steering wheel.



□ The Air collar ensures comfort when driving by pleasantly providing warmth for the head and shoulders. When the roof is open, the warming system integrated into the front seat headrests is automatically regulated based on the speed and outside temperature. Three different temperature levels can also be personally selected.



□ The Automatic air conditioning with 3-zone control and automatic temperature control features separate controls for you and your front passenger, as well as for the passengers in the rear. It also includes Automatic Air Recirculation (AAR), a micro active carbon filter, a fog and solar sensor, as well as rear air vents with a digital display.



□ The tonally outstanding Harman Kardon surround sound system features a 408 W digital amplifier, nine channels and 12 speakers. Its sophisticated sound perfectly fills the interior space. Vehicle-specific, speed-dependent equalising precisely compensates for any background driving noise.

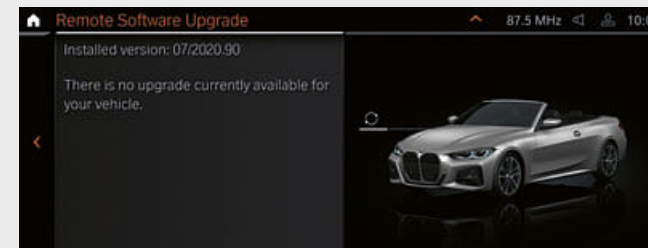

□ Do you want your BMW to be up to date with the latest software? With Remote Software Upgrade*, your BMW will always be up to date. Upgrades are installed over the air, just as they are for your smartphone. In this way, other functions in your vehicle can also be activated.

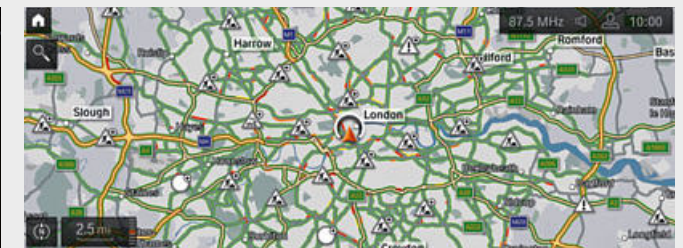

□ BMW Maps – Connected Navigation* impresses with high accuracy of the predicted arrival time, extremely fast route calculation and simplified destination entry. This is possible through free text input. The cloud-based dynamic route calculation immediately adapts the route recommendation to any changes in the traffic situation.



□ The safety package Driving Assistant¹* includes the camera-based systems front collision warning with brake intervention, Speed Limit Assist incl. Speed Limit Info with no-overtaking indicator and pre-warning as well as Lane Departure Warning. Additionally, the radar-based equipment includes rear crossing traffic warning, Lane Change Warning and rear collision warning.



□ Parking Assistant² makes parking the vehicle easier. The Reversing Assist Camera provides a clearer view behind the vehicle. Active Park Distance Control offers increased protection against damage caused by parking. Parking Assistant parks the vehicle automatically, parallel or perpendicular to the street, and leaves parallel parking spaces. The Reversing Assistant supports you when reversing, e.g. in narrow lanes.



□ Surround View includes the camera-based functions Top View, Panorama View and 3D View*. Cameras at the front, at the rear and in the exterior mirrors allow a 360° view to be shown on the Control Display, as well as an overhead view. Panorama View makes it easier to approach intersections and driveways with low visibility.



□ Telephony with wireless charging³ incorporates a wireless charging dock and a second microphone for a better hands-free voice quality for you and your front passenger. An additional aerial connection improves mobile reception. Two mobile telephones and an audio player can be connected simultaneously via Bluetooth. Also included is the technical capacity for a Wi-Fi hotspot.

¹ Function may be limited in darkness, fog or bright glare.
² The driver is responsible for constantly monitoring the automated parking procedure in accordance with local road laws.

³ Supports inductive charging for Qi-compatible mobile phones. Special charging cases are available from Original BMW Accessories for selected smartphones that do not support the Qi standard for inductive charging.

*The availability of some equipment features and functions depends on engine variants or additional options. The market and production availability may vary. You can find

detailed information about terms, standard and optional equipment at www.bmw.com or at your BMW Partner.

EXTERIOR COLOURS.

Discover even more with the new BMW Brochures app. Available now, for your smartphone and tablet.

■ Standard equipment □ Optional equipment

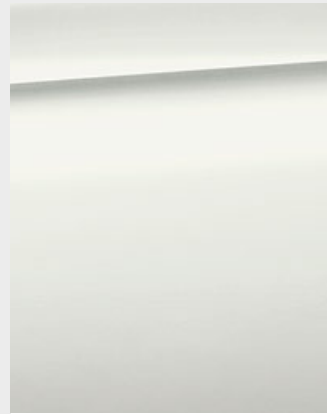

□ Non-metallic 300 Alpine White¹



■ Non-metallic 668 Black



□ Metallic A96 Mineral White²



□ Metallic C2Y Bluestone

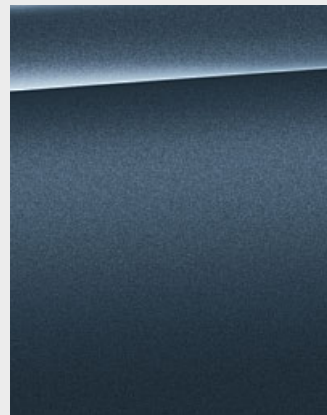

□ Metallic C4F Arctic Race Blue²

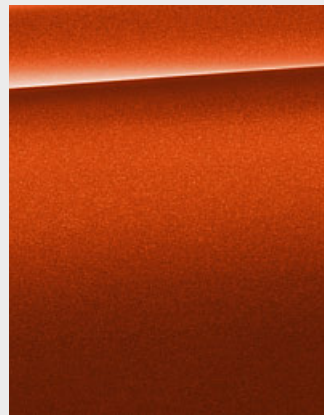

□ Metallic C1X Sunset Orange

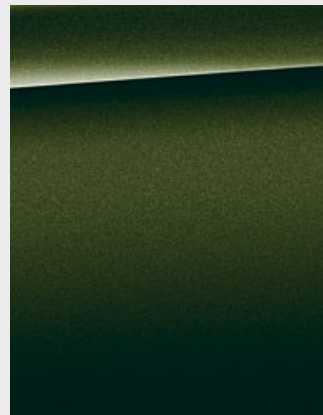

□ Metallic C4E Sanremo Green²

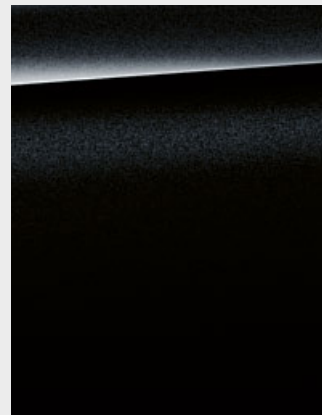

□ Metallic 475 Black Sapphire²

M SPORT PACKAGE



□ Metallic C31 M Portimao Blue³



□ Metallic C4P M Brooklyn Grey³

BMW INDIVIDUAL



□ BMW Individual special paintwork Brilliant White metallic²

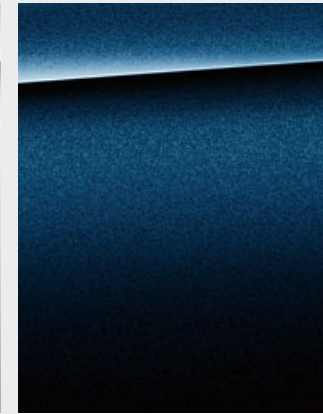

□ BMW Individual C3Z Tanzanite Blue metallic²

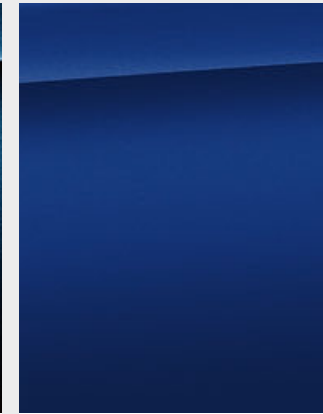

□ BMW Individual X1E Frozen Portimao Blue metallic²

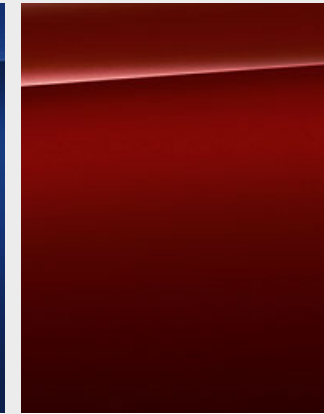

□ BMW Individual C57 Aventurine Red metallic²



□ BMW Individual special paintwork Frozen Deep Grey metallic²

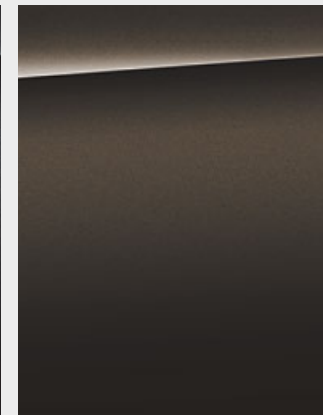

□ BMW Individual C36 Dravit Grey metallic²

CONVERTIBLE TOP



■ 388 Black



□ 3YA Anthracite silver effect

[Colour samples] These colour samples are intended as an initial guide to the colours and materials available for your BMW. However, experience has shown that printed versions of paint, upholstery and interior trim colours cannot in all

cases faithfully reproduce the appearance of the original colour. Please discuss your preferred colour choices with your BMW partner or dealership. There you can also see original samples and be assisted with special requests.

¹ Available as standard for M440i xDrive and M Sport package.
² Also optionally available for M440i xDrive and M Sport package.
³ Exclusively available for M440i xDrive and M Sport package.

The availability of some equipment features and functions depends on engine variants or additional options. The market and production availability may vary. You can find detailed information about terms, standard and optional equipment at www.bmw.com or at your BMW Partner.

INTERIOR COLOURS.

Discover even more with the new BMW Brochures app. Available now, for your smartphone and tablet.

■ Standard equipment □ Optional equipment

SENSATEC

Available with



- Base
- M Sport package

Sensatec KHSW perforated Black*

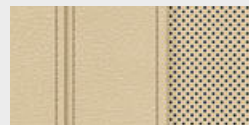

- Base
- M Sport package

Sensatec KHFR Canberra Beige with extended contents*

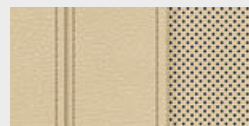

- Base
- M Sport package

Sensatec KHFS Canberra Beige with extended contents*

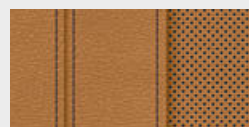

- Base
- M Sport package

Sensatec KHKC Cognac with extended contents*

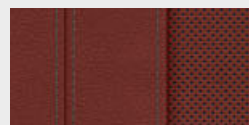

- Base
- M Sport package

Sensatec KHG7 Tacora Red*

STOFF-SENSATEC-KOMBINATION

Available with



- Base

Cloth/Sensatec combination KFSW Black

LEATHER

Available with



- Base
- M Sport package

Leather 'Vernasca' MAOI Oyster with decorative stitching, interior colour Black*

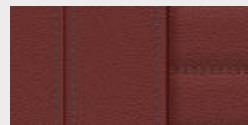

- Base
- M Sport package

Leather 'Vernasca' MAG6 Tacora Red with decorative stitching, interior colour Black*



- Base
- M Sport package

Leather 'Vernasca' MAMU Mocha with decorative stitching, interior colour Black*

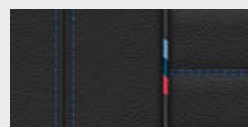

- M Sport package

Leather 'Vernasca' MANL Black, contrast stitching Blue, interior colour Black*



- Base
- M Sport package

Leather 'Vernasca' MAH7 Black decor stitching, interior colour Black*

BMW INDIVIDUAL LEATHER

Available with



- Base
- M Sport package

BMW Individual extended leather trim 'Merino' VAEW Ivory White, interior colour Black*



- Base
- M Sport package

BMW Individual full leather trim 'Merino' VBEW Ivory White, interior colour Black*



- Base
- M Sport package

BMW Individual extended leather trim 'Merino' VATQ Tartufo, interior colour Black*



- Base
- M Sport package

BMW Individual full leather trim 'Merino' VBTQ Tartufo, interior colour Black*

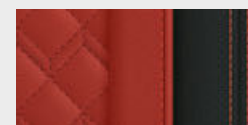

- Base
- M Sport package

BMW Individual extended leather trim 'Merino' VAHZ Fiana Red/Black, interior colour Black*



- Base
- M Sport package

BMW Individual full leather trim 'Merino' VBHZ Fiana Red/Black, interior colour Black*



- Base
- M Sport package

BMW Individual extended leather trim 'Merino' ZAFV Fjord Blue/Black, interior colour Black*



- Base
- M Sport package

BMW Individual full leather trim 'Merino' ZBFV Fjord Blue/Black, interior colour Black*

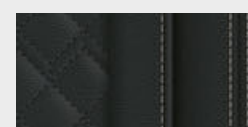

- Base
- M Sport package

BMW Individual extended leather trim 'Merino' ZASW Black, interior colour Black*

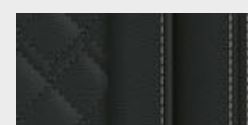

- Base
- M Sport package

BMW Individual full leather trim 'Merino' ZBSW Black, interior colour Black*

INTERIOR TRIM FINISHERS

Available with



- Base

BMW Individual interior trim finishers piano finish Black with highlight trim finisher Pearl Chrome



- M Sport package

M interior trim finishers Aluminium Tetragon with highlight trim finisher Pearl Chrome

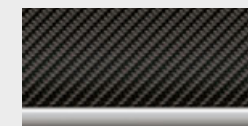

- M Sport package

M interior trim finishers 'Carbon Fibre' with highlight trim finisher Pearl Chrome*



- Base
- M Sport package

Interior trim finishers Aluminium 'Mesheffect' with highlight trim finisher in Pearl Chrome



- Base
- M Sport package

Interior trim finishers in fine-wood trim oak grain open-pored with highlight trim finisher Pearl Chrome

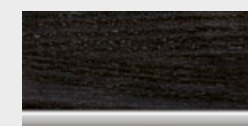

- Base
- M Sport package

Interior trim finishers in fine-wood trim Ash grey-brown high-gloss with highlight trim finisher Pearl Chrome

BMW INDIVIDUAL INTERIEURLEISTEN

Available with



- Base
- M Sport package

BMW Individual interior trim finishers Aluminium fabric high-gloss with highlight trim finisher in Pearl Chrome



- Base
- M Sport package

BMW Individual fine-wood trim 'Fineline' Black with silver effect open-pored and highlight trim finisher in Pearl Chrome



- Base
- M Sport package

BMW Individual fine-wood trim 'Fineline' Black with silver effect open-pored and highlight trim finisher in Pearl Chrome

Please note that even normal long- or short-term use can lead to unrecoverable upholstery damage. This can be caused in particular by non-colourfast clothing.

*The availability of some equipment features and functions depends on engine variants or additional options. The market and production availability may vary. You can find detailed information about terms, standard and optional equipment at www.bmw.com or at your BMW Partner.

WHEELS AND TYRES.

Discover even more with the new BMW Brochures app. Available now, for your smartphone and tablet.



■ 17" light alloy wheels V-spoke style 778 Reflex Silver, wheel size 7.5J x 17 with 225/50 R17 tyres.*



□ 18" light alloy wheels V-spoke style 780 Bicolour Orbit Grey, gloss-lathed, wheel size 7.5J x 18 with 225/45 R18 tyres.*



□ 18" light alloy wheels Double-spoke style 782 Bicolour Jet Black uni, gloss-lathed, wheel size 7.5J x 18 with 225/45 R18 tyres.*



■ 18" M light alloy wheels Double-spoke style 848 M Bicolour Jet Black with mixed tyres, gloss-lathed, wheel size front 7.5J x 18 with 225/45 R18 tyres, wheel size rear 8.5J x 18 with 255/40 R18 tyres.¹



□ 19" light alloy wheels Y-spoke style 783 Bicolour Jet Black with mixed tyres and run-flat tyres, gloss-lathed, wheel size front 8J x 19 with 225/40 R19 tyres, wheel size rear 8.5J x 19 with 255/35 R19 tyres.*



□ 19" M light alloy wheels Double-spoke style 791 M Jet Black uni with mixed tyres and run-flat tyres, wheel size front 8J x 19 with 225/40 R19 tyres, wheel size rear 8.5J x 19 with 255/35 R19 tyres.¹



□ 19" M light alloy wheels Double-spoke style 792 M Bicolour Cerium Grey with mixed tyres and run-flat tyres, gloss-lathed, wheel size front 8J x 19 with 225/40 R19 tyres, wheel size rear 8.5J x 19 with 255/35 R19 tyres.²



□ 19" BMW Individual light alloy wheels Double-spoke style 793 I Bicolour Orbit Grey with mixed tyres and run-flat tyres, gloss-lathed, wheel size front 8J x 19 with 225/40 R19 tyres, wheel size rear 8.5J x 19 with 255/35 R19 tyres.



□ 19" M light alloy wheels Double-spoke style 797 M Bicolour Jet Black matt with mixed tyres and run-flat tyres, gloss-lathed, wheel size front 8J x 19 with 225/40 R19 tyres, wheel size rear 8.5J x 19 with 255/35 R19 tyres.¹

ORIGINAL BMW ACCESSORIES AND BMW M PERFORMANCE PARTS.

■ Standard equipment □ Optional equipment ○ Accessories



○ Show your style: The frame of the M Performance front grille is made of hand-crafted premium carbon fibre and the decorative slats consist of extra sturdy plastic. A visual highlight at the front of the vehicle for an especially elegant, sporty and individual look.



○ Details make the difference: The M Performance fuel filler cap carbon fibre enhances the vehicle's sporty, individual look.

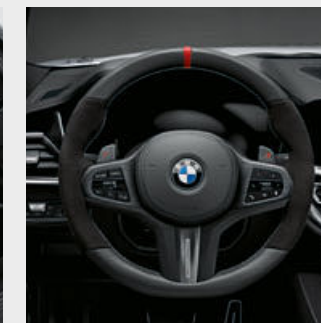

○ Gripping facts: The steering wheel with Alcantara-lined grip area provides excellent feel and grip for a sportier steering feel.



○ Wireless charging, any time and anywhere: Thanks to the BMW wireless charging station universal the smartphone can be charged comfortably and efficiently without a cable in the vehicle. The mobile phone is saved in a stable and safe way. Especially smart: The integrated powerbank can be removed and enables wireless charging outside the vehicle.



○ The perfectly fitted, durable BMW all-weather floor mats with a raised border and elegant design protect the front footwell against moisture and dirt. They are black and feature a stainless steel inlay.



○ The BMW Pro 2.0 rear bicycle rack is lightweight yet sturdy and can carry up to 60 kg. Exceptionally easy to use, it carries two bicycles or e-bikes (can be extended to accommodate three bicycles). Its tilt function also allows easy access to the luggage compartment at all times.

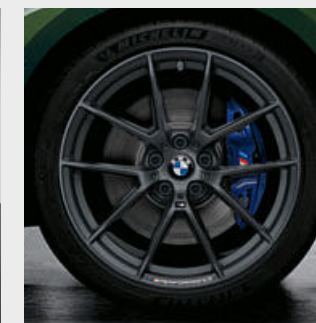

○ 19" M Performance light alloy wheels Y-spoke style 898 M in Frozen Gunmetal Grey. Summer complete wheel set with tyre pressure monitor.

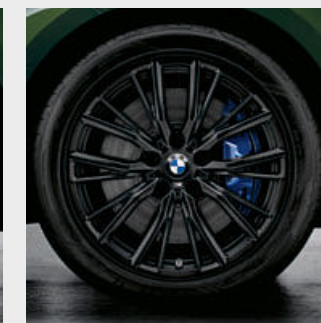

○ High-quality 20" M Performance forged wheels Y-spoke style 795 M in Jet Black matt. TPMS summer complete wheel set with run-flat tyres.

¹ Only available for M440i xDrive and M Sport package.
² Only available for M440i xDrive.

The availability of some equipment features and functions depends on engine variants or additional options. The market and production availability may vary. You can find detailed information about terms, standard and optional equipment at www.bmw.com or at your BMW Partner.

Discover the wide range of innovative solutions available for the exterior and interior, communication and information, and for transportation and the luggage compartment. Your BMW Partner is on hand to advise you on the whole range of Original BMW Accessories

and the BMW M Performance Parts product portfolio. For further information, please visit www.bmw.com

BMW 4 Series Convertible		420i	430i	M440i xDrive ⁶ with mild hybrid technology	420d ⁶ with mild hybrid technology	430d ⁶ with mild hybrid technology
Weight						
Unladen weight EU (xDrive) ¹	kg	1765	1790	(1965)	1850	1955
Max. permissible weight (xDrive)	kg	2185	2200	(2390)	2270	2380
Permitted load (xDrive)	kg	495	485	(500)	495	500
Permitted trailer load, unbraked (xDrive) ²	kg	750	750	(750)	750	750
Permitted trailer load, braked, max. 12% gradient/max. 8% gradient (xDrive) ²	kg	1600/1600	1600/1600	(1800/1800)	1600/1600	1800/1800
Luggage capacity	l	300–385	300–385	300–385	300–385	300–385
BMW TwinPower Turbo engine³						
Cylinders/valves	–	4/4	4/4	6/4	4/4	6/4
Capacity	cm ³	1998	1998	2998	1995	2993
Max. output/engine speed	kW (hp)/ rpm	135 (184)/ 5000–6500	190–180 (258–245)/ 4500–6500	275 (374)/ 5500–6500	140–120 (190–163)/ 4000	210 (286)/ 4000
With mild hybrid technology	kW (hp)	–	–	+8 (11)	+8 (11)	+8 (11)
Max. torque/engine speed	Nm/ rpm	300/ 1350–4000	400/ 1550–4400	500/ 1900–5000	400/ 1750–2500	650/ 1500–2500
Power transmission						
Type of drive (xDrive)	–	Rear-wheel	Rear-wheel	(all-wheel)	Rear-wheel	Rear-wheel
Standard transmission (xDrive)	–	8-speed Steptronic	8-speed Steptronic	(8-speed Steptronic Sport)	8-speed Steptronic	8-speed Steptronic
Driving performance						
Top speed (xDrive)	km/h	236	250 ⁵	(250) ⁵	236–225	250 ⁵
Acceleration 0–100 km/h (xDrive)	s	8.2	6.2	(4.9)	7.6–8.3	5.8
Consumption^{3,4} – All engines conform to the EU6 standard						
Low (xDrive)	l/100 km	9.2–9.9	– ⁷	(11.7–12.3)	6.1–6.8	– ⁷
Medium (xDrive)	l/100 km	6.8–7.5	– ⁷	(7.9–8.7)	4.8–5.4	– ⁷
High (xDrive)	l/100 km	5.8–6.4	– ⁷	(6.6–7.2)	4.3–4.9	– ⁷
Maximum value (xDrive)	l/100 km	6.4–7.1	– ⁷	(7.1–7.8)	4.9–5.6	– ⁷
Combined (xDrive)	l/100 km	6.7–7.3	– ⁷	(7.8–8.4)	4.9–5.5	– ⁷
Exhaust emissions standard (type-certified)	–	EU6d	EU6d	EU6d	EU6d	EU6d
Combined CO ₂ emissions (xDrive)	g/km	152–167	– ⁷	(177–192)	128–144	– ⁷
Tank capacity, approx.	l	59	59	59	59	59
Wheels/tyres						
Tyre size (xDrive)		225/50 R17 Y	225/50 R17 Y	Front: 225/45 R18 Y Rear: 255/40 R18 Y	225/50 R17 Y	225/50 R17 Y
Wheel size (xDrive)		7.5 J x 17	7.5 J x 17	Front: 7.5 J x 18 Rear: 8.5 J x 18	7.5 J x 17	7.5 J x 17
Material		Light alloy	Light alloy	Light alloy	Light alloy	Light alloy

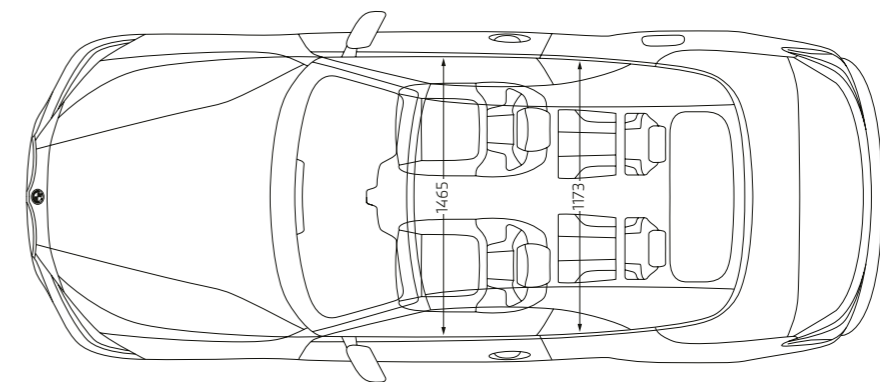
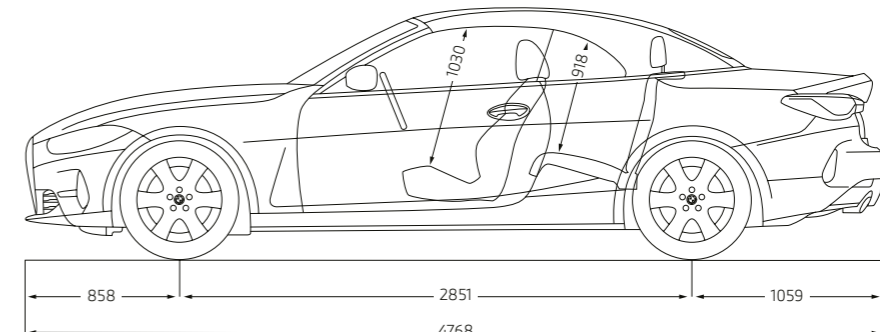
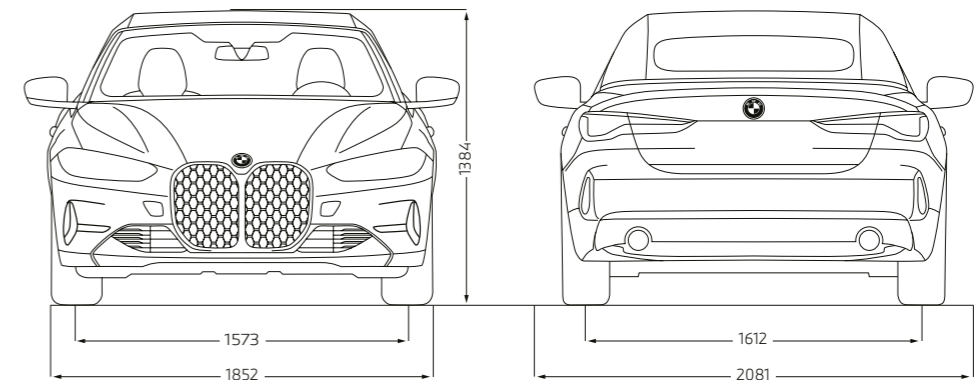

All dimensions in the technical drawing are given in millimetres. The dimensions for M440i xDrive may vary. The figures for performance, fuel consumption and CO₂ emissions refer to vehicles with standard transmission.

- ¹ The EC unladen weight refers to a vehicle with standard equipment and does not include any optional extras. The unladen weight includes a 90% full tank and a driver weight of 75 kg. Optional equipment may affect the weight of the vehicle, the payload and the top speed if the selected equipment has an impact on the vehicle's aerodynamics.
- ² The actual total weight of the trailer must not exceed the maximum trailer load, taking into account the maximum tow bar download.
- ³ Performance data of petrol engines apply to vehicles using RON 98 fuel. Fuel consumption data apply to vehicles using reference fuels in accordance with EU Regulation 2007/715. Unleaded RON 91 and higher with a maximum ethanol content of 10% (E10) may also be used. BMW recommends RON 95 super unleaded petrol.
- ⁴ Official data for fuel consumption and CO₂ emissions was determined in accordance with the prescribed measuring procedure and corresponds to European Regulation (EC) 715/2007 in the applicable version. For ranges, data determined as per WLTP takes into account any optional equipment (available on the German market in this case). For vehicles that have been newly type approved since 1 January 2021, only the official data according to WLTP exists. For more information about NEDC and WLTP measuring procedures visit www.bmw.com/wltp
- ⁵ Electronically limited.
- ⁶ This engine version is not available in all countries. For further information, please contact your local BMW Partner.
- ⁷ Provisional figures; any missing figures were unavailable at the time of publication.



ALL BMW MODELS IN ONE APP.

DOWNLOAD THE **BMW Products** APP NOW AND
DISCOVER THE PLEASURE OF DRIVING.

BMW 430i CONVERTIBLE WITH M SPORT PACKAGE:

BMW TwinPower Turbo 4-cylinder petrol engine, 190 kW (258 hp), 19" BMW Individual light alloy wheels Double-spoke style 793 I Bicolour, exterior colour in Sanremo Green metallic, BMW Laserlight, standard seats in leather 'Vernasca' Oyster decor stitching, interior trim finishers in fine-wood trim oak grain open-pored.

The models illustrated in this medium show the equipment and configuration options (standard and optional) for vehicles produced by BMW AG for the German market. Alterations in standard and optional equipment and the configurations available for the different models, as described in this medium, may occur after 03/19/2021, the editorial deadline for this medium, or according to the specific requirements of other member states of the European Union. Your local BMW Partner is available to provide further details. Subject to change in design and equipment.

Of course, each vehicle is designed for economical recycling after its long-running life. You can find more information regarding your end-of-life vehicle on our website www.bmw.de/recycling.

© BMW AG, Munich, Germany. Not to be reproduced wholly or in part without prior written permission of BMW AG, Munich.