



Sheer
Driving Pleasure



THE 3

TOURING

THE NEW BMW 3 SERIES TOURING.



DISCOVER MORE DIGITALLY: THE NEW BMW BROCHURE APP.



More information, more sheer driving pleasure: The new BMW brochure app offers a digital and interactive BMW experience like never before. Download the BMW brochure app for your smartphone or tablet now and rediscover your BMW.

INNOVATION AND TECHNOLOGY.



18 Powertrain and suspension



20 Driver assistance
21 Safety

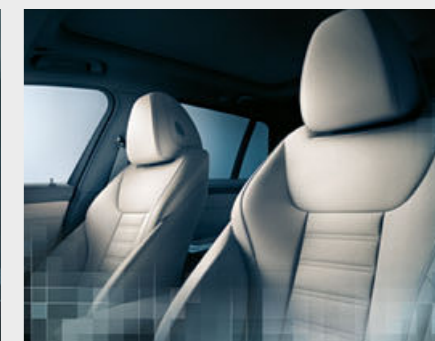

22 Connectivity and infotainment
23 Comfort and functionality

EQUIPMENT.

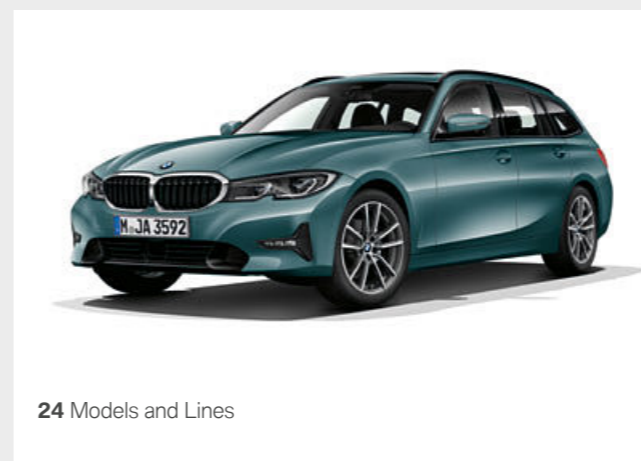

24 Models and Lines



30 BMW Individual



32 Additional equipment

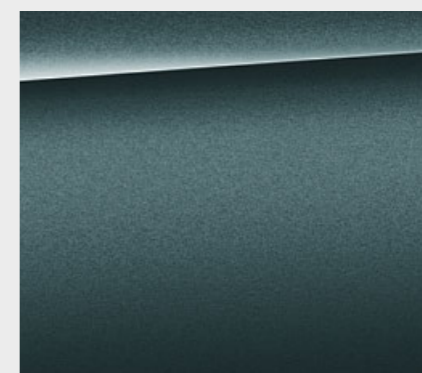

36 Exterior colour world

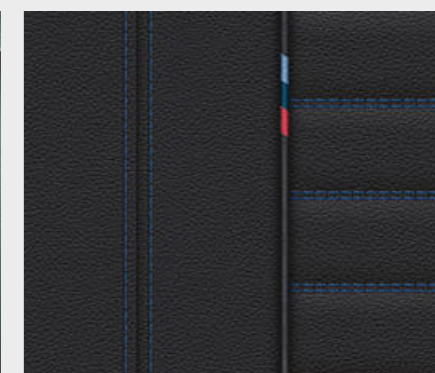

38 Interior colour world



40 Colour worlds, wheels and tyres



41 Original BMW Accessories

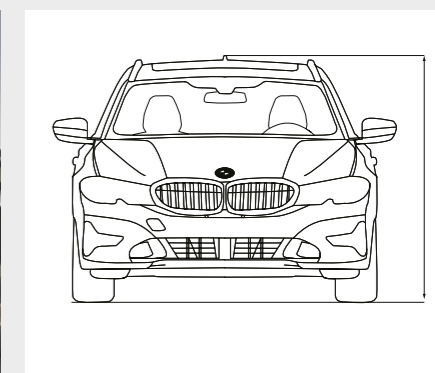

42 Technical data

IN GREAT
SHAPE.



PHYSICS KNOWS BOUNDARIES.
ENTHUSIASM DOESN'T.

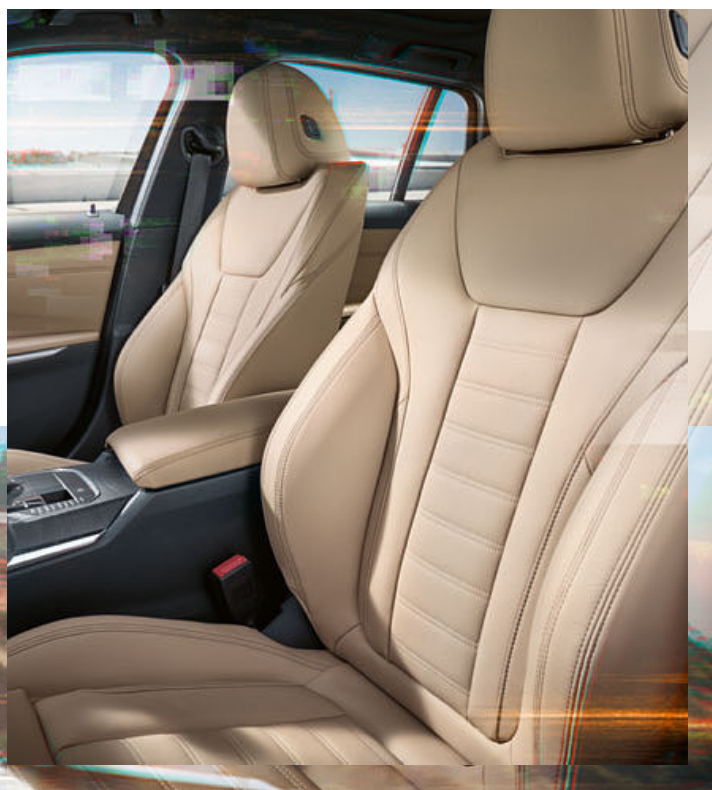



**DISTINCTIVE SHAPES FOR
A MEMORABLE APPEARANCE.**



THE CAR THAT
THINKS FOR YOU.



ATTRACTIVELY POWERFUL.

GIVES XL PLANS
XXL POSSIBILITIES.



AHEAD OF
ANY CHALLENGE.



Sporty, versatile and self-confident athletic proportions, dynamic silhouette and optimal aerodynamics II BMW Laserlight¹ II Well-toned shoulder section II LED rear lights II 19" BMW Individual light alloy wheels¹. **Innovative driver assistance and connectivity** BMW Intelligent Personal Assistant^{1,*} II Driving Assistant Professional with extensive safety and comfort features^{1,*} II Customisable BMW Live Cockpit Professional with a 12.3" instrument display and a 10.25" Control Display^{1,*} II Digital Key^{1,2,*}. **Functional and comfortable equipment** Welcome Light Carpet¹ II Improved interior acoustics II Through-loading system with 40:20:40-split rear seatback II Large, flexible luggage compartment II Luggage-compartment package with anti-slip rail¹ II Separately opening rear window. **Outstanding driving dynamics and impressive efficiency** BMW M340i xDrive³ II M Sport differential^{1,4,*} II Adaptive M suspension¹ II Active air stream kidney grille II Efficient Lightweight II Plug-in hybrid model⁵. **Functionality in its sportiest form – the new BMW 3 Series Touring.**

¹ Available as optional equipment.

² Prerequisite is a BMW ConnectedDrive account and a compatible smartphone with Android operating system, NFC technology and integrated secure element. Only compatible with selected Android smartphones with Android 8.0 or higher. For customers with non-compatible smartphones, a high-quality key card is provided.

³ Available from 11/2019.

⁴ Standard for M340i xDrive.

⁵ Available from 07/2020.

*The availability of some equipment features and functions depends on engine variants or additional options. The market and production availability may vary. You can find detailed information about terms, standard and optional equipment at www.bmw.com or from your BMW Partner. Some ConnectedDrive Services may differ between countries. Please consult your local BMW partner for more information.

BMW EFFICIENT DYNAMICS.
LESS EMISSIONS. MORE DRIVING PLEASURE.

■ Standard equipment □ Optional equipment



ENGINE HIGHLIGHTS OF THE NEW BMW 3 SERIES TOURING.

BMW 330i
BMW TwinPower Turbo 4-cylinder petrol engine with 190 kW (258 hp) and 400 Nm torque
Acceleration 0–100 km/h: 5.9 s
Top speed: 250 km/h
Fuel consumption combined: 6.0–6.4 l/100 km
Combined CO₂ emissions: 136–146 g/km

BMW M340i xDrive⁴
BMW TwinPower Turbo 6-cylinder petrol engine with 275 kW (375 hp) and 500 Nm torque¹
Acceleration 0–100 km/h: 4.5 s¹
Top speed: 250 km/h²
Fuel consumption combined: 7.1–7.5 l/100 km¹
Combined CO₂ emissions: 162–170 g/km¹

■ The **Standard suspension** with double-joint spring-strut front axle and five-arm rear axle offers a high level of precision, agility and comfort.

□ The **M sport differential^{3,*}** optimises traction and driving stability when driving dynamically or on different road surfaces.

□ The **M Sport suspension^{3,*}** is set approximately 10 mm lower and features more athletic settings.

□ The powerful **M Sport brake^{3,*}** features large brake discs and exclusive blue-painted brake callipers with the M logo.

□ The lowered **Adaptive M suspension*** with variable shock absorber adjustment offers the choice between comfortable and sporty suspension design.

■ For maximum traction, driving dynamics and safety, the **BMW xDrive** all-wheel drive system provides variable drive power distribution to the front and rear axles.

AERODYNAMICS

■ Thanks to targeted aerodynamic measures, every BMW boasts excellent air resistance figures. This has a positive impact on efficiency and driving stability, and reduces the level of noise in the interior. This is thanks to sophisticated solutions such as the Active air stream kidney grille, the flat underbody cover, the Air Blades on the rear or the Air curtain in the front apron.

ACTIVE AIR STREAM KIDNEY GRILLE

■ The Active air stream kidney grille opens and closes the air vents in the radiator grille according to the cooling requirements of the engine and the air conditioning. The movable vents are located behind the kidney grille slats and at the same time reduce air resistance when closed, thereby improving aerodynamics.

STEPTRONIC SPORT TRANSMISSION

□ The 8-speed Steptronic Sport transmission* offers incredibly sporty gear changes. Whether automatic or manual using gearshift paddles or gear lever – for comfortable coasting or incredibly dynamic driving. In SPORT mode and with the gear lever in the left-hand S/M position, the gear shifts are configured for the best performance.

DRIVING EXPERIENCE CONTROL

■ Driving Experience Control* offers the driver the choice between the standard COMFORT mode, the more efficient ECO PRO mode, and the SPORT and SPORT+ modes, for an even more dynamic drive. The optional interactive Adaptive Mode function continuously adjusts the adaptive suspension, the steering and the Steptronic transmission to suit the current driving situation.

BRAKE ENERGY REGENERATION

■ With Brake Energy Regeneration, the alternator generates electricity primarily when you brake or take your foot off the accelerator. Previously unused kinetic energy is thereby transformed into electrical energy and fed into the battery.

INTELLIGENT AUTOMATIC START/STOP FUNCTION

□ The Intelligent Auto Start Stop function* uses data from the navigation system, camera and radar-based systems to analyse the current traffic situation. If it is detected that further travel is imminent (e.g. during a turning manoeuvre), the engine is not automatically switched off when the vehicle stops.



¹ Provisional figures; any missing figures were unavailable at the time of publication.

² Electronically limited.

³ Standard for M340i xDrive.

⁴ Available from 11/2019.

* The availability of some equipment features and functions depends on engine variants or additional options. The market and production availability may vary. You can find detailed information about terms, standard and optional equipment at www.bmw.de or from your BMW Partner.

DRIVER ASSISTANCE.

BMW Personal CoPilot. By your side, when you decide.

□ **Driving Assistant Professional^{1,*}** offers optimum comfort and maximum safety during lots of critical or monotonous driving situations with Steering and lane control assistant incl. support in narrow places, Emergency Stop Assistant, local hazard warning, Lane Keeping Assistant with active side collision protection and other safety functions.

□ **Active cruise control with Stop&Go function*** maintains within a speed range of 30 to 160 km/h a pre-defined distance from the vehicle ahead, including stopping and restarting in stop-and-go traffic. Speed Limit Assist allows the takeover of speed limits in the cruise control. The front collision warning with braking intervention reacts to stationary vehicles, pedestrians and cyclists.

□ The **Steering and lane control assistant* incl. support in narrow places** can be activated to support you in monotonous traffic situations. At speeds of up to 210 km/h on all road surfaces with Active cruise control, the system conveniently supports steering and keeps the vehicle in the centre of its lane.

□ **Parking Assistant Plus*** makes parking and manoeuvring the vehicle easier. It features among others the Surround View system including Top View, Panorama View, Remote View 3D, as well as a lateral parking aid, the emergency braking function Active Park Distance Control, Parking Assistant with linear guidance and Reversing Assistant.

□ The **Lateral parking aid*** is a part of Park Distance Control and gives you an "all-round view" near the vehicle during manoeuvring. In this way, obstacles on the sides of the vehicle are detected and signalled audibly and visually.

□ The **Reversing Assistant*** stores the last 50 m of the driven path in forward travel up to 35 km/h, so that it can be retracted if required. You are relieved of the steering work and can concentrate on monitoring the vehicle environment.

SAFETY.

■ Standard equipment □ Optional equipment

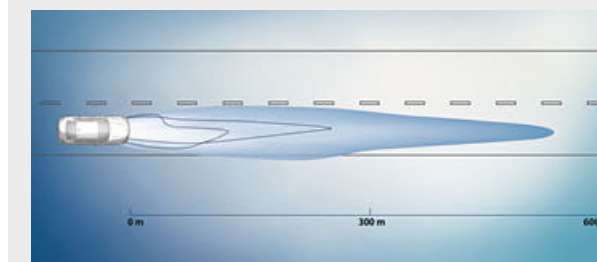

□ The Adaptive **BMW Laserlight** extends the maximum illumination range in high-beam mode to up to 530 m.



□ The **Crossing traffic warning rear*** warns you of crossing traffic when pulling out of perpendicular parking spaces.



■ **Active Guard** includes the front collision warning with braking function and Lane Departure Warning.

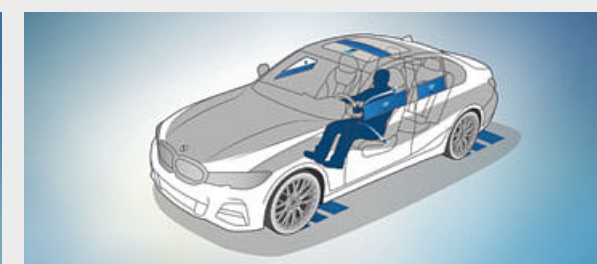

□ The preventive occupant protection **Active Protection** takes precautions in critical situations.

¹ Function may be limited in darkness, fog or bright glare.

The Standard and Optional equipment may differ between countries. Please consult your local BMW partner for more information.
* The availability of some equipment features and functions depends on engine variants or additional options. The market and production availability may vary.
You can find detailed information about terms, standard and optional equipment at www.bmw.com or from your BMW Partner.

CONNECTIVITY AND INFOTAINMENT.

BMW ConnectedDrive Connected to be free.



BMW INTELLIGENT PERSONAL ASSISTANT

'Hey, BMW. Who are you?' Wouldn't it be incredible if your BMW also came with a personal assistant? Communicate with your vehicle using the BMW Intelligent Personal Assistant*. It knows you, gets better every day and helps out whatever the situation. You can assign your own personal activation word. It can explain everything about your car and helps you to get to know your BMW even better.

CONNECTED PACKAGE PROFESSIONAL

Concierge Service, Remote Services, Apple CarPlay® preparation, In-Car Experiences or the Connected Navigation services Real Time Traffic Information and parking space assistant? Why order them individually? Get them all! With the Connected Package Professional*, you can enjoy these BMW ConnectedDrive services as well as free additional services to test.

CARING CAR

Arrive with fresh energy? Relax when stressed? No problem with Caring Car*. When you say, 'Hey, BMW. I'm tired,' or 'Hey, BMW. I'm feeling stressed,' your BMW Intelligent Personal Assistant will launch the Vitalize or Relax programme. Both stimulate your senses by coordinating the interplay of various interior functions.

BMW LIVE COCKPIT PROFESSIONAL

The BMW Live Cockpit Professional* with navigation function includes a high-quality display network consisting of a high-resolution 10.25" Control Display that can be operated by touch and a fully digital 12.3" instrument display. The BMW Operating System 7.0 can also be operated via the iDrive Controller.

BMW DIGITAL KEY

Why take your key with you if you have your Android smartphone with you? The Digital Key^{1,*} or Key Card allows you to lock and unlock your BMW and even start the engine without needing a physical key. It can be downloaded to your Android smartphone using the BMW Connected app and shared with family and friends.

REMOTE SOFTWARE UPGRADE

Do you want your BMW to be up to date with the latest software? With Remote Software Upgrade*, your BMW will always be up to date – without having to visit your BMW service partner. Upgrades are installed over-the-air, just as they are for your smartphone. In this way, other functions in your vehicle can also be activated.

¹ Prerequisite is a BMW ConnectedDrive account and a compatible smartphone with Android operating system, NFC technology and integrated secure element.
* Only compatible with selected Android smartphones with Android 8.0 or higher. For customers with non-compatible smartphones, a high-quality key card is provided. Some ConnectedDrive Services may differ between countries. Please consult your local BMW partner for more information.

COMFORT AND FUNCTIONALITY.

■ Standard equipment □ Optional equipment

■ The **Through-loading system** includes rear seat backrests that can be divided in a 40:20:40 ratio for the greatest possible flexibility. For example, two passengers can be seated comfortably in the rear, while long objects such as ski and snowboard bags can be transported at the same time. The two cupholders in the centre armrest are very practical.

In addition to the electric remote backrest unlocking, the **Luggage-compartment package** also includes practical slide and anti-slip rails for easy loading into the luggage compartment or for securing heavy items of luggage during the journey.

■ The **child seat ISOFIX attachment** allows the secure attachment of one or two ISOFIX child seats.

■ **Personal Profile** saves all the driver's personal settings. When the vehicle is opened, the settings for the driver seat, exterior mirror position and automatic air conditioning (temperature and air distribution) are automatically restored. The profile can be transferred to other BMW vehicles with suitable equipment via BMW Online or a USB stick.

■ The **rear window, which can be opened separately**, is particularly practical for stowing or removing smaller pieces of luggage without having to open the entire tailgate.



The Standard and Optional equipment may differ between countries. Please consult your local BMW partner for more information.
* The availability of some equipment features and functions depends on engine variants or additional options. The market and production availability may vary. You can find detailed information about terms, standard and optional equipment at www.bmw.com or from your BMW Partner.

BASE.

Discover even more with the new BMW Brochures app. Available now, for your smartphone and tablet.



□ The black Sport leather steering wheel with four spokes features a Pearl Chrome decorative trim. A thick rim and contoured thumb rests provide an exceptionally pleasant, high-grip feel.

■ The standard seats for driver and front passenger can be adjusted manually in the fore-and-aft position, backrest angle, headrest height and seat angle as well as seat height.

Base model equipment features

- Standard seats in Cloth 'Hevelius'
- Interior trim finishers Quartz Silver matt, grained
- Leather steering wheel incl. multifunction buttons
- 17" light alloy wheels V-spoke style 778
- BMW Live Cockpit, 8.8" Control Display incl. touch function
- Hands-free function with USB interface
- Automatic air conditioning
- Automatic tailgate operation
- LED headlights
- Roof rails black



□ 17" light alloy wheels V-spoke style 775 Bicolour Orbit Grey, burnished, wheel size 7.5J x 17 with 225/50 R17 tyres.



■ 17" light alloy wheels V-spoke style 778 Reflex Silver, wheel size 7.5J x 17 with 225/50 R17 tyres.

LUXURY LINE.

Equipment 24 | 25

■ Standard equipment □ Optional equipment

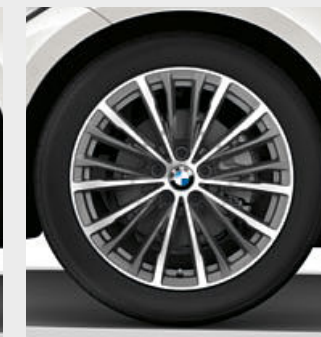
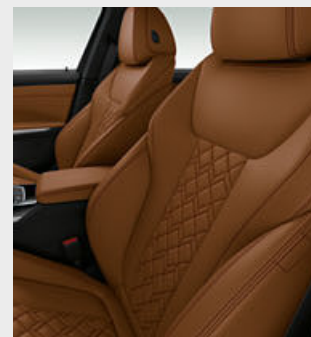

■ The black Sport leather steering wheel with a thick rim and contoured thumb rests has an exceptionally pleasant, high-grip feel.

□ The Sport seats for driver and front passenger feature optimum support and various adjustment options, including backrest width.

■ 17" light alloy wheels Double-spoke style 771 Reflex Silver, wheel size 7.5J x 17 with 225/50 R17 tyres.

□ 18" light alloy wheels Multi-spoke style 781 Bicolour Ferric Grey with runflat tyres, burnished, 7.5J x 18 with 225/45 R18 tyres.

Luxury Line exterior equipment:

- BMW kidney grille with exclusively designed vertical slats and grille frame in Chrome, cross rod in Black high-gloss
- Front bumper with specific design elements in Black high-gloss and side air intakes in Chrome high-gloss
- 17" light alloy wheels Double-spoke style 771; other wheels available
- Mirror foot, B-pillar trim and window guide in Black high-gloss
- Trim on the side window frames and window recess finishers in Chrome high-gloss, alternatively in Black high-gloss
- Roof rails in Aluminium satinated, alternatively in Black high-gloss
- Rear bumper with side air intakes in Chrome high-gloss

Luxury Line interior equipment:

- Front door sill finishers in Aluminium with "BMW" lettering
- Seats in Leather 'Vernasca' Black with Grey contrast stitching; other upholsteries available
- Sport leather steering wheel, alternatively M Leather steering wheel
- Line-specific vehicle key with chrome clasp
- Instrument panel Sensatec with double stitching
- Interior trim finishers in Fine-wood trim Ash grey-brown high-gloss; other trims available

SPORT LINE.

Discover even more with the new BMW Brochures app. Available now, for your smartphone and tablet.



■ The black Sport leather steering wheel with a thick rim and contoured thumb rests has an exceptionally pleasant, high-grip feel.

■ The Sport seats for driver and front passenger feature optimum support and various adjustment options, including backrest width.

■ 17" light alloy wheels V-spoke style 776 Ferric Grey, wheel size 7.5J x 17 with 225/50 R17 tyres.

□ 18" light alloy wheels V-spoke style 780 Bicolour Orbit Grey with runflat tyres, 7.5J x 18 with 225/45 R18 tyres.

Sport Line exterior equipment:

- BMW kidney grille with exclusively designed vertical slats and grille frame in Chrome, cross rod in Black matt
- Front bumper with specific design elements and side air intakes in Black high-gloss
- 17" light alloy wheels V-spoke style 776; other wheels also available
- Exterior mirror caps in body colour, alternatively in Black high-gloss
- BMW Individual high-gloss Shadow Line with mirror foot, B-pillar trim, window guide, window recess finisher, trim on the front and rear window frames in Black high-gloss, alternatively BMW Individual Exterior Line Aluminium satinated
- BMW Individual roof rails high-gloss Shadow Line, alternatively roof rails Aluminium satinated
- Rear bumper with specific T-shaped design elements and an insert in Black high-gloss
- Tailpipe trim strip in Chrome

Sport Line interior equipment:

- Front door sill finishers in Aluminium with "BMW" lettering
- Sport seats in Cloth/Sensatec combination Black with grey contrast stitching; other upholsteries available
- Sport leather steering wheel, alternatively M Leather steering wheel
- Line-specific vehicle key with chrome clasp
- Interior trim finishers in Black high-gloss, other trims available

M SPORT PACKAGE.

Equipment 26 | 27

■ Standard equipment □ Optional equipment

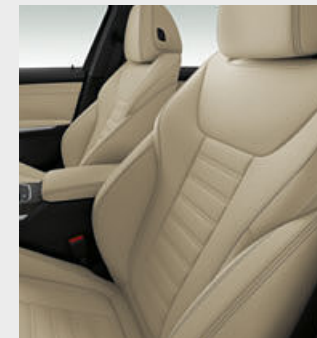

■ M Leather steering wheel including multifunction buttons, steering wheel rim in leather 'Walknappa' Black with contoured thumb rests.

■ The Sport seats for driver and front passenger feature optimum support and various adjustment options, including backrest width.

■ 18" M light alloy wheels Double-spoke style 790 M Bicolour Orbit Grey with mixed tyres, burnished, front 7.5J x 18 with 225/45 R18 tyres, rear 8.5J x 18 with 255/40 R18 tyres.

□ 19" M light alloy wheels Double-spoke style 791 M Bicolour Jet Black with mixed tyres and runflat tyres, burnished, front 8J x 19 with 225/40 R19 tyres, rear 8.5J x 19 with 255/35 R19 tyres.

M Sport package exterior equipment:

- M Aerodynamics package with front apron, side sills and rear apron in body colour with diffuser insert in Dark Shadow metallic
- BMW kidney grille with exclusively designed vertical slats in black high-gloss and grille frame in Chrome high-gloss, alternatively grille frame in black high-gloss
- LED fog lights
- 18" M light alloy wheels Double-spoke style 790 M Bicolour Orbit Grey with mixed tyres; other wheels available
- M Sport brake with blue painted brake callipers with M designation
- M Sport suspension incl. Variable sport steering; other suspensions available
- BMW Individual high-gloss Shadow Line, alternatively BMW Individual Exterior Line Aluminium satinised
- BMW Individual roof rails high-gloss Shadow Line, alternatively roof rails Aluminium satinated
- M designation on the sides
- Exterior mirror caps in body colour, alternatively in Black high-gloss
- Tailpipe trims in Chrome high-gloss, alternatively in Black high-gloss
- Exclusive paintwork in Portimao Blue metallic; other paintworks available

M Sport package interior equipment:

- M door sill finishers
- M driver footrest and M pedals
- Floor mats with exclusive M designation*
- Sport seats for the driver and front passenger in Alcantara/Sensatec combination with perforation and Blue contrast stitching
- Sport seats for driver and front passenger in leather 'Vernasca' Black with contrast stitching in Blue featuring instrument panel in Sensatec with exclusive blue stitching; other upholsteries available
- M Leather steering wheel
- Vehicle key with exclusive M designation
- BMW Individual headliner anthracite
- Instrument cluster with M specific display
- Interior trim finishers in Aluminium Tetragon, other trims available
- Shortened gear lever with exclusive M designation for manual transmission

The Standard and Optional equipment may differ between countries. Please consult your local BMW partner for more information.

* The availability of some equipment features and functions depends on engine variants or additional options. The market and production availability may vary. You can find detailed

information about terms, standard and optional equipment at www.bmw.com or from your BMW Partner.

BMW M340i xDrive.

The new BMW M340i xDrive Touring.



You will feel, hear and see the difference: The new BMW M340i xDrive Touring¹ boasts a characteristic M TwinPower Turbo 6-cylinder petrol engine, whose 275 kW (374 hp) catapults the vehicle in just 4.5 seconds from a standstill to 100 km/h². The specifically tuned M Sport suspension as well as the sensitive Variable sport steering guarantee a particularly dynamic steering and cornering performance as well as absolute control. The design also makes clear statements in terms of dynamics: From the BMW kidney grille with mesh design to the double-flanged tailpipes, from the M leather steering wheel to the ergonomic Sport seats, numerous details add to the powerful character of the new BMW M340i xDrive Touring and spread a true racing feeling in everyday life. Enjoy every metre – in the new BMW M340i xDrive Touring.



BMW 330e.

The new BMW 330e plug-in hybrid Touring.

■ Standard equipment □ Optional equipment



The BMW 330e³ with its state-of-the-art plug-in hybrid drive meets the highest demands of driving dynamics and efficiency. The combination of the eDrive electric motor and four-cylinder petrol engine provides exhilarating driving performance and driving pleasure typical of the brand. In pure electric mode the vehicle is even free of local emissions on the road.



□ The all-digital instrument cluster creates an adrenaline-loaded ambience with its exclusive "M340i" model designation, which is further enhanced by the M leather steering wheel with gearshift paddles.



■ The model designation of the M340i xDrive can be found on the right side of the tailgate and is designed in Cerium Grey.



■ The door sill finisher at the front with the "M340i" model designation conveys sporty elegance when the doors are opened.



■ The 8-speed Steptronic Sport transmission offers incredibly sporty gear changes. Whether automatic or manual using gearshift paddles or gear lever.



BMW TwinPower Turbo 4-cylinder petrol engine

Electric motor

Lithium-ion high-voltage battery



■ In eDrive drive, the drive modes HYBRID, ELECTRIC, and BATTERY CONTROL can be selected using specific control buttons.



■ The vehicle can be conveniently charged at home at a special wallbox or with the specially designed charging cable supplied.

¹ Expected to be available from 11/2019.
² Provisional figures. Any missing figures were unavailable at the time of publication.

³ Expected to be available from 07/2020.

The Standard and Optional equipment may differ between countries. Please consult your local BMW partner for more information.

BMW INDIVIDUAL.

THE EXPRESSION OF PERSONALITY.



The paint finish BMW Individual Frozen Dark Grey metallic accentuates the sporty character of the new BMW 3 Series Touring. A special pigmentation embedded within the multi-layer painting process produces the characteristic silk-matt gloss of the surface.



Carefully preselected, finest premium leather is the basis for the BMW Individual full leather trim 'Merino' Ivory White. The elaborate natural tanning gives it a particularly soft and pleasant feel.



In the interior, selected trim finishers such as the interior trim finishers BMW Individual Aluminium fabric high-gloss set extraordinary accents that attract attention and demonstrate a sense of something special.

If someone decides, then you: BMW Individual offers you all the options to customise the new BMW 3 Series Touring according to your personal wishes, with the degree of customisation entirely up to you. Add your personal driving experience to the typical BMW driving pleasure. Choose what suits you the most from particularly high-quality equipment options: Exclusive BMW Individual paint finishes that show style and confidence. Soft, voluminous leather trims and interior trim finishers made of fine woods, which turn the interior into your personal comfort zone. Or go your very own way, only following your ideas – BMW Individual ensures that they become an automotive reality.

ADDITIONAL EQUIPMENT.

Discover even more with the new BMW Brochures app. Available now, for your smartphone and tablet.

■ Standard equipment □ Optional equipment



■ Automatic tailgate operation allows the convenient opening and closing of the tailgate by simply pressing the relevant button.

□ Contactless opening and closing of the tailgate* is part of the Comfort access system. In situations where the user's hands are full, all that's necessary is a targeted motion of the foot under the rear bumper and the process is carried out conveniently and automatically. They just need to be carrying the vehicle key with them.



□ The Adaptive LED headlights with cornering lights generate a bright and efficient bi-LED light for low and high-beam headlights. The bend lighting and cornering lights with LED technology allow for adaptive light distribution with increased side illumination for city driving. The LED daytime running lights and parking lights in the light tubes of the main headlights create a distinctive feature characteristic of a BMW.



□ The Trailer tow hitch¹ with electrically adjustable tow ball and trailer stability control is approved for heavy loads of up to 1,800 kg.



□ The BMW Individual high-gloss Shadow Line with extended contents* includes the kidney grille frame and the BMW kidney grille in black high-gloss and tailpipe trims in Black Chrome.



□ In addition to the electric remote backrest unlocking, the Luggage-compartment package also includes practical slide and anti-slip rails for easy loading into the luggage compartment or for securing heavy items of luggage during the journey.



■ The rear lights with their characteristic L-shape and lighting elements in full LED technology identify the vehicle as a BMW even in the dark.



□ Your car key? No need for that anymore. The Digital Key^{2.0}* exists on your Android smartphone, and you can share it with friends.



□ The BMW Individual Exterior Line in Aluminium satinated* sets luxurious highlights with the window recess finishers and window surrounds in silk matt brushed aluminium. The B-pillar trims, the exterior mirror frames, foot and base, along with the vertical window guides, come in black high-gloss, creating a stylish contrast to these elements.



■ The rear window, which can be opened separately, is particularly practical for stowing or removing smaller pieces of luggage without having to open the entire tailgate.



□ The Storage compartment package includes a hinged compartment on the driver's side of the instrument panel, nets on the back of the front-seat backrests, as well as two USB ports with charging function in the rear centre console. There is also an extra storage net on the right side for smaller items and a tensioning belt on the right side.



□ The Roof rails in Aluminium satinated match perfectly with the vehicle's design and provide the base for a multifunctional BMW roof rack unit to which roofboxes, bicycles, surfboards etc. can be secured.



□ The BMW Individual roof rails high-gloss Shadow Line* in Black high-gloss adds a premium-quality touch. Lying flat on the roof, it forms the basis for a multifunctional BMW roof rack unit that carries a roofbox, bicycles, surf boards etc. easily and securely.

¹ Available as optional equipment.
² Prerequisite is a BMW ConnectedDrive account and a compatible smartphone with Android operating system, NFC technology and integrated secure element. Only

compatible with selected Android smartphones with Android 8.0 or higher. For customers with non-compatible smartphones, a high-quality key card is provided.

*The availability of some equipment features and functions depends on engine variants or additional options. The market and production availability may vary. You can find detailed information about terms, standard and optional equipment at www.bmw.com or from your BMW Partner.

Some ConnectedDrive Services may differ between countries. Please consult your local BMW partner for more information. The Standard and Optional equipment may differ between countries. Please consult your local BMW partner for more information.

ADDITIONAL EQUIPMENT.

Discover even more with the new BMW Brochures app. Available now, for your smartphone and tablet.

■ Standard equipment □ Optional equipment



□ The large, full-colour BMW Head-Up Display¹* projects all information relevant to the journey directly into your field of vision, allowing you to fully concentrate on driving. Information such as the current speed, navigation directions, Speed Limit Info including no-overtaking indicator, along with telephone and entertainment lists are displayed.



□ Ambient light, including Ambient contour lighting in the front and rear doors, creates a relaxed, cosy lighting atmosphere in the interior. The six dimmable lighting designs also include a dynamic function in four applications. The Welcome Light Carpet illuminates the area in front of the vehicle doors when entering and exiting.



□ Concierge Service, Remote Services, Apple CarPlay[®] preparation³, In-Car Experiences or the Connected Navigation services Real Time Traffic Information and parking space assistant? Why order them individually? Get them all! With the Connected Package Professional*, you can enjoy these BMW ConnectedDrive services as well as free additional services to test.



□ Do you want your BMW to be up to date with the latest software? With Remote Software Upgrade*, your BMW will always be up to date – without having to visit your BMW service partner. Upgrades are installed over-the-air, just as they are for your smartphone. In this way, other functions in your vehicle can also be activated.



□ The BMW Live Cockpit Professional* with navigation function includes a high-quality display network consisting of a high-resolution 10.25" Control Display that can be operated by touch and a fully digital 12.3" instrument display. The BMW Operating System 7.0 can also be operated via the iDrive Controller.



□ Telephony with wireless charging incorporates a wireless charging² dock and a second microphone for a better hands-free voice quality for you and your front passenger. A roof aerial connection improves mobile reception. Two mobile telephones and an audio player can be connected simultaneously via Bluetooth. Also included is the technical capacity for a WiFi hotspot.



□ When open, the Panorama glass roof provides a great deal of fresh air. Closed, it creates a bright, light-flooded atmosphere in the interior. It opens and closes completely automatically at the push of a button or with the vehicle key, and is equipped with slide and lift functions, electric roller sunblind and wind deflector.

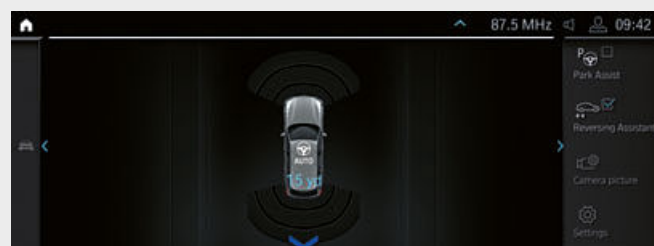

□ The Reversing Assistant* stores the last 50m of the driven path in forward travel up to a speed of 35km/h, so that it can be retraced if required.



□ Parking Assistant Plus* makes parking and manoeuvring the vehicle easier. It features among others the Surround View system including Top View, Panorama View, Remote View 3D, as well as a lateral parking aid, the emergency braking function Active Park Distance Control, Parking Assistant with linear guidance and Reversing Assistant.



□ The tonally outstanding Harman Kardon surround sound system* features a 464W digital amplifier, nine channels and 16 speakers. Its sophisticated sound perfectly fills the interior space. Vehicle-specific, speed-dependent equalising precisely compensates for any background driving noise.



■ The Through-loading system includes rear seat backrests that can be divided in a 40:20:40 ratio for the greatest possible flexibility. For example, two passengers can be seated comfortably in the rear, while long objects such as ski and snowboard bags can be transported at the same time. The two cupholders in the centre armrest are very practical.

¹ The information in the BMW Head-Up Display is not fully visible when viewed through polarised sunglasses. Content shown will depend on the equipment options chosen. Further optional equipment is required to display specific items.
² Supports inductive charging for Qi-compatible mobile phones. Special charging cases are available from Original BMW Accessories for selected smartphones that do not

support the Qi standard for inductive charging. The WiFi hotspot fulfils all in-vehicle requirements for use of the internet with the maximum LTE standard. Usage is subject to cost.
³ Apple CarPlay[®] compatibility and supported functions depend on the model year and the software installed on the iPhone[®]. When the Apple CarPlay[®] preparation is in use, selected vehicle data is transferred to the phone. The mobile phone manufacturer is responsible for further data processing..

* The availability of some equipment features and functions depends on engine variants or additional options. The market and production availability may vary. You can find detailed information about terms, standard and optional equipment at www.bmw.com or from your BMW Partner.

Some ConnectedDrive Services may differ between countries. Please consult your local BMW partner for more information. The Standard and Optional equipment may differ between countries. Please consult your local BMW partner for more information.

EXTERIOR COLOUR WORLD.

Discover even more with the new BMW Brochures app. Available now, for your smartphone and tablet.

■ Standard equipment □ Optional equipment

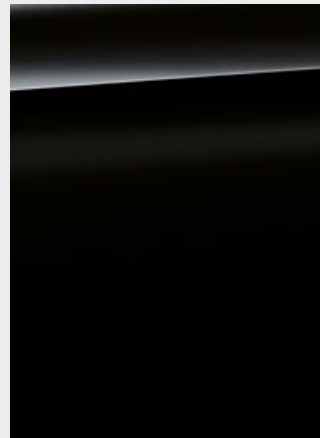

■ Non-metallic 668 Black

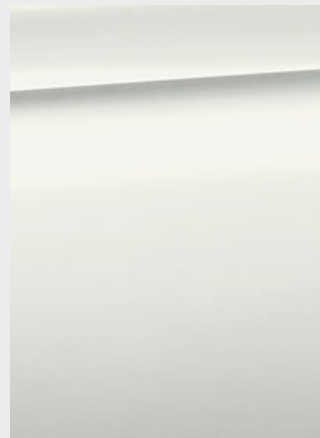

□ Non-metallic 300 Alpine White¹



□ Metallic A96 Mineral White²



□ Metallic A83 Glacier Silver



□ Metallic B39 Mineral Grey²

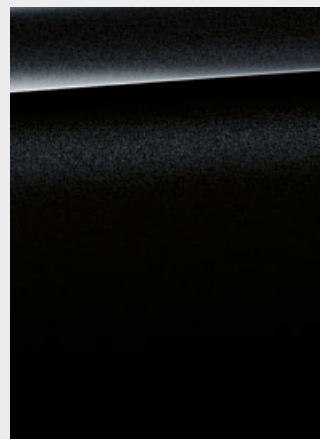

□ Metallic 475 Black Sapphire²

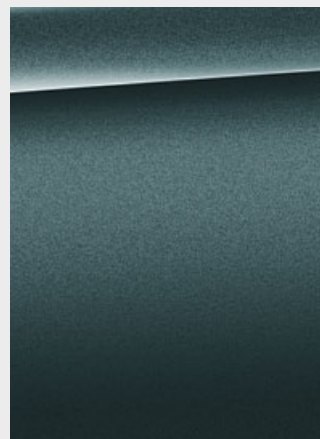

□ Metallic C35
Blue Ridge Mountain



□ Metallic C10
Mediterranean Blue

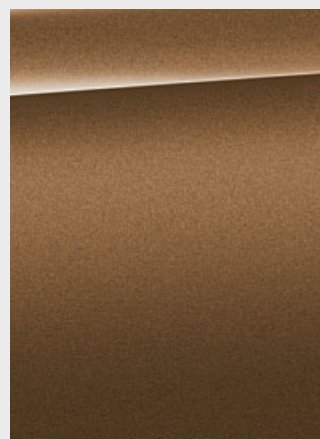

□ Metallic C1Z Vermont Bronze

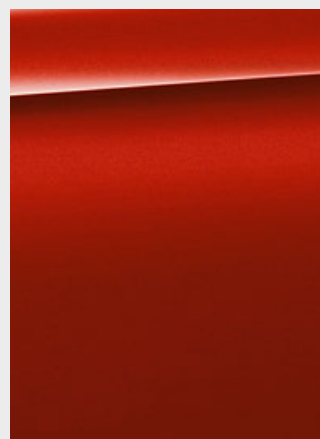

□ Metallic A75 Melbourne Red

BMW INDIVIDUAL



□ BMW Individual 490
special paintwork
(e.g. Brilliant White metallic)²

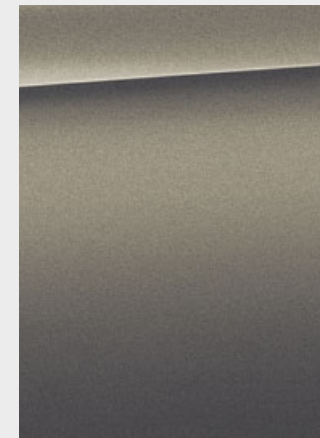

□ BMW Individual C4A
Oxide Grey metallic²

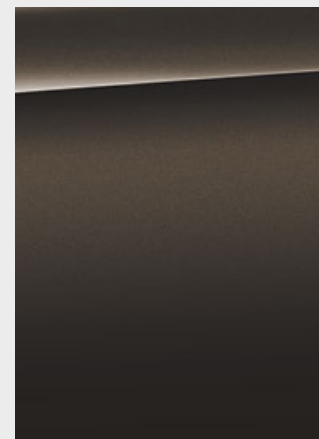

□ BMW Individual C36
Dravit Grey metallic²



□ BMW Individual 490
Frozen Dark Grey metallic²

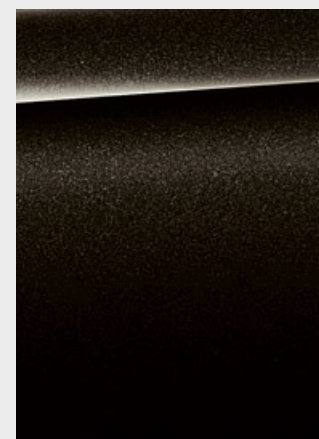

□ BMW Individual C49
Citrine Black metallic²

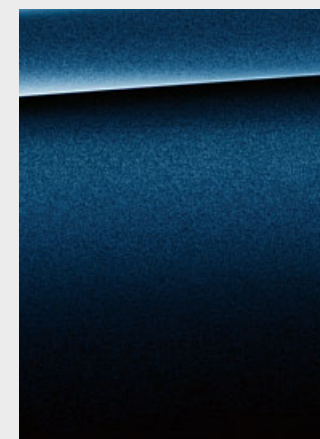

□ BMW Individual C3Z
Tanzanite Blue metallic²

M SPORT PACKAGE



□ Metallic C31 Portimao Blue^{3,*}

[Colour samples] These colour samples are intended as an initial guide to the colours and materials available for your BMW. However, experience has shown that printed versions of paint, upholstery and interior trim colours cannot in all cases faithfully reproduce the

appearance of the original colour. Please discuss your preferred colour choices with your BMW partner or in your dealership. There you can also see original samples and be assisted with special requests.

The Standard and Optional equipment may differ between countries. Please consult your local BMW partner for more information.

¹ Available as standard with the M Sport package and from 07/19 for M340i xDrive.

² Optionally available with the M Sport package and from 07/19 for M340i xDrive.

³ Exclusively available with the M Sport package and from 07/19 for M340i xDrive.

*The availability of some equipment features and functions depends on engine variants or additional options. The market and production availability may vary. You can find detailed information about terms, standard and optional equipment at www.bmw.com or from your BMW Partner.

INTERIOR COLOUR WORLD.

Discover even more with the new BMW Brochures app. Available now, for your smartphone and tablet.

■ Standard equipment □ Optional equipment

CLOTH

Available with

- Base

Cloth 'Hevelius' EHAT Anthracite, interior colour Black



CLOTH-SENSATEC COMBINATION

Available with

- Base
- Sport Line

Cloth/Sensatec combination KFSW Black*



Available with

- M Sport package

Alcantara/Sensatec combination KGNL Black with perforation, accent Blue



SENSATEC

Available with

- Base
- Sport Line

Sensatec KCSW Black



BMW INDIVIDUAL LEDER

Available with

- Base
- Luxury Line
- Sport Line
- M Sport package

BMW Individual extended leather trim 'Merino' VAEW Ivory White*, interior colour Black



Available with

- Base
- Luxury Line
- Sport Line
- M Sport package

BMW Individual extended leather trim 'Merino' VATQ Tartufo*, interior colour Black



Available with

- Base
- Luxury Line
- Sport Line
- M Sport package

BMW Individual extended leather trim 'Merino' ZASW Black*, interior colour Black



Available with

- Base
- Luxury Line
- Sport Line
- M Sport package

BMW Individual extended leather trim 'Merino' VAHZ Fiona Red/Black*, interior colour Black

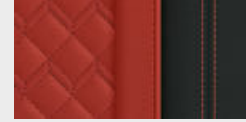

Available with

- Base
- Luxury Line
- Sport Line
- M Sport package

BMW Individual extended leather trim 'Merino' ZAFV Fjord Blue/Black*, interior colour Black



Available with

- Base
- Luxury Line
- Sport Line
- M Sport package

BMW Individual full leather trim 'Merino' VBEW Ivory White*, interior colour Black



Available with

- Base
- Luxury Line
- Sport Line
- M Sport package

BMW Individual full leather trim 'Merino' VBTQ Tartufo*, interior colour Black



Available with

- Base
- Luxury Line
- Sport Line
- M Sport package

BMW Individual full leather trim 'Merino' ZBSW Black*, interior colour black



Available with

- Base
- Luxury Line
- Sport Line
- M Sport package

BMW Individual full leather trim 'Merino' VBHZ Fiona Red/Black*, interior colour Black

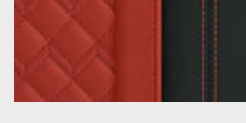

Available with

- Base
- Luxury Line
- Sport Line
- M Sport package

BMW Individual full leather trim 'Merino' ZBFV Fjord Blue/Black*, interior colour Black



BMW INDIVIDUAL INTERIOR TRIM FINISHERS

Available with

- Base
- Luxury Line
- Sport Line
- M Sport package

BMW Individual interior trim finishers Aluminium fabric high-gloss with highlight trim finisher in Pearl Chrome

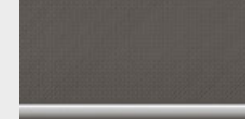

Available with

- Base
- Luxury Line
- Sport Line
- M Sport package

BMW Individual interior trim finishers piano finish Black with highlight trim finisher Pearl Chrome



Available with

- Base
- Luxury Line
- Sport Line
- M Sport package

BMW Individual fine-wood trim 'Fineline' Black with silver effect open-pored and highlight trim finisher in Pearl Chrome



LEATHER

Available with

- Base
- Luxury Line
- Sport Line
- M Sport package

Leather 'Vernasca' MAOI Oyster with decorative stitching*, interior colour Black

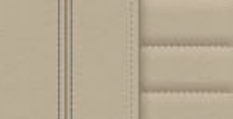

INTERIOR TRIM FINISHERS

Available with

- Base

Interior trim finishers Quartz Silver matt, grained



Available with

- Base
- Luxury Line
- Sport Line
- M Sport package

Interior trim finishers Aluminium 'Mesheffect' with highlight trim finisher in Pearl Chrome

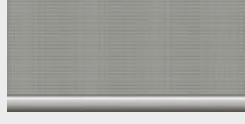

Available with

- M Sport package

Interior trim finishers Aluminium Tetragon with highlight trim finisher in Pearl Chrome



Available with

- Base
- Luxury Line
- Sport Line

Interior trim finishers Black high-gloss with highlight trim finisher in Pearl Chrome



Available with

- Base
- Luxury Line
- Sport Line
- M Sport package

Interior trim finishers in fine-wood trim maple open-pored with highlight trim finisher Pearl Chrome



Available with

- Base
- Luxury Line
- Sport Line
- M Sport package

Interior trim finishers in fine-wood trim oak grain open-pored with highlight trim finisher Pearl Chrome



Available with

- Base
- Luxury Line
- Sport Line
- M Sport package

Interior trim finishers in fine-wood trim Ash grey-brown high-gloss with highlight trim finisher Pearl Chrome



Available with

- Base
- Luxury Line
- Sport Line
- M Sport package

Leather 'Vernasca' MAPQ Cognac with decorative stitching*, interior colour Black



Available with

- Base
- Luxury Line
- Sport Line
- M Sport package

Leather 'Vernasca' MAMU Mocha with decorative stitching, interior colour Black

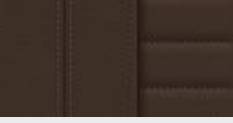

Available with

- Base
- Luxury Line
- Sport Line
- M Sport package

Leather 'Vernasca' MAH7 Black decor stitching, interior colour Black



Available with

- Sport Line

Leather 'Vernasca' MANJ Black with decorative stitching, exclusive stitching in Orange

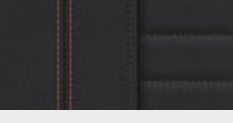

Available with

- M Sport package

Leather 'Vernasca' MANL Black, contrast stitching Blue, interior colour Black*



Please note that even normal long- or short-term use can lead to unrecoverable upholstery damage. This can be caused in particular by non-colourfast clothing.

Please note that the interior colour depends on the selected upholstery colour.

*The availability of some equipment features and functions depends on engine variants or additional options. The market and production availability may vary. You can find detailed information about terms, standard and optional equipment at www.bmw.com or from your BMW Partner.

The Standard and Optional equipment may differ between countries. Please consult your local BMW partner for more information.

WHEELS AND TYRES.

Discover even more with the new BMW Brochures app. Available now, for your smartphone and tablet.



□ 17" light alloy wheels V-spoke style 775 Bicolour Orbit Grey, burnished, wheel size 7.5J x 17 with 225/50 R17 tyres.



■ 17" light alloy wheels V-spoke style 778 Reflex Silver, wheel size 7.5J x 17 with 225/50 R17 tyres.



□ 18" light alloy wheels Double-spoke style 782 Bicolour Orbit Grey, burnished, 7.5J x 18 with 225/45 R18 tyres.



□ 19" M light alloy wheels Double-spoke style 791 M Jet Black uni with mixed tyres and runflat tyres¹, burnished, front 8J x 19 with 225/40 R19 tyres, rear 8.5J x 19 with 255/35 R19 tyres.



□ 19" M light alloy wheels Double-spoke style 792 M Bicolour Cerium Grey with mixed tyres and runflat tyres²*, burnished, front 8J x 19 with 225/40 R19 tyres, rear 8.5J x 19 with 255/35 R19 tyres.



□ 19" BMW Individual light alloy wheels Double-spoke style 793 in Bicolour Orbit Grey with mixed tyres and runflat tyres, burnished, front 8J x 19 with 225/40 R19 tyres, rear 8.5J x 19 with 255/35 R19 tyres.

ORIGINAL BMW ACCESSORIES.

Equipment 40 | 41

■ Standard equipment □ Optional equipment ○ Accessories



○ The BMW rear bicycle rack Pro 2.0 is lightweight yet sturdy and can carry up to 60 kg. Outstandingly easy to handle, it can transport two bicycles or e-bikes (can be extended to accommodate three bicycles). Its tilt function allows easy access to the luggage compartment at any time.



○ The universal holder is adjustable in terms of size and is attached to the separately available basic carrier or to the optional equipment "Travel & Comfort". It provides a secure hold for a wide range of Apple or Samsung tablets with BMW safety case from 7" to 11". It can be rotated by 360° and locked in any desired inclination.



○ The modern BMW roof box in black with titanium silver side panels has a storage capacity of 420 litres and is compatible with all BMW roof rack systems. Due to the fact that it can be opened from both sides and has triple central locking on each side it is convenient to load and lock for theft protection.



○ Precisely fitted protection against moisture and dirt in the front footwell. Featuring a black design with a stainless steel inlay, they perfectly complement the interior.



○ Anti-slip, water-resistant mat for protecting the luggage compartment from dirt and moisture. In black with stainless steel inlay matching the interior.

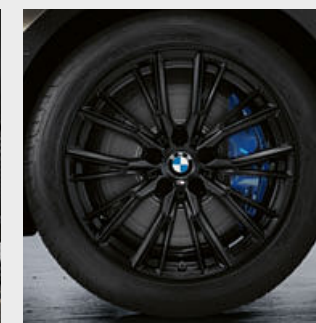

○ High-quality 18" M Performance light alloy wheel Double-spoke style 796 M in Jet Black matt. TPMS winter complete front wheel with run-flat mixed tyre.



○ This innovative vehicle interior mirror incorporates an adaptive universal remote control for up to three garage doors and property gates.

¹ Only available in conjunction with M Sport package and M340i xDrive.
² Only available for M340i xDrive.
* The availability of some equipment features and functions depends on engine variants or

additional options. The market and production availability may vary. You can find detailed information about terms, standard and optional equipment at www.bmw.com or from your BMW Partner.

Discover the wide range of innovative solutions available for the exterior and interior, communication and information, and for transportation and the luggage compartment. Your BMW Partner is on hand to advise you on the whole range of Original BMW Accessories. For more information, visit www.bmw.com

The Standard and Optional equipment may differ between countries. Please consult your local BMW partner for more information.

BMW 3 Series Touring		320i	330i 330i xDrive	M340i xDrive ¹¹	318d ¹¹	320d 320d xDrive	330d ¹¹ 330d xDrive	330e ¹²
----------------------	--	------	---------------------	----------------------------	--------------------	---------------------	-----------------------------------	--------------------

Weight								
Unladen weight EU (xDrive) ¹	kg	[1570] ¹⁰	[1650] ([1715])	[(1770)] ¹⁰	1575 ¹⁰ [1585] ¹⁰	1640 [1660] ([1715])	[1715] ¹⁰ ([1820])	1830 ¹⁰
Max. permissible weight (xDrive)	kg	– ¹⁰	[2185] ([2260])	– ¹⁰	– ¹⁰	2180 [2190] ([2255])	– ¹⁰ ([2350])	– ¹⁰
Permitted load (xDrive)	kg	– ¹⁰	[610] ([620])	– ¹⁰	– ¹⁰	615 [605] ([615])	– ¹⁰ ([605])	– ¹⁰
Permitted trailer load, unbraked (xDrive) ²	kg	– ¹⁰	[750] ([750])	– ¹⁰	– ¹⁰	750 [750] ([750])	– ¹⁰ ([750])	– ¹⁰
Permitted trailer load, braked, max. 12% gradient/max. 8% gradient (xDrive) ²	kg	– ¹⁰	[1600/1600] ([1800/1800])	– ¹⁰	– ¹⁰	1600/1600 [1800/1800] ([1800/1800])	– ¹⁰ ([1800/1800])	– ¹⁰
Luggage capacity	l	– ¹⁰	500–1510	– ¹⁰	– ¹⁰	500–1510	500–1510	– ¹⁰

BMW TwinPower Turbo engine ³								
Cylinders/valves	–	– ¹⁰	4/4	– ¹⁰	– ¹⁰	4/4	6/4	– ¹⁰
Capacity	cm ³	– ¹⁰	1998	– ¹⁰	– ¹⁰	1995	2993	– ¹⁰
Max. output/engine speed	kW (hp)/rpm	135 (184) ^{–10}	190 (258)/ 5000–6500	275 (375) ^{–10}	110 (150) ^{–10}	140 (190)/ 4000	195 (265)/ 4000	135 (184) ^{–10}
Max. torque/engine speed	Nm/rpm	300 ^{–10}	400/ 1550–4400	500 ^{–10}	320 ^{–10}	400/ 1750–2500	580/ 1750–2750	300 ^{–10}

eDrive motor								
Max. output	kW (hp)	–	–	–	–	–	–	83 (113) ¹⁰
Max. torque	Nm	–	–	–	–	–	–	265 ¹⁰
System output	kW (hp)	–	–	–	–	–	–	215 (292) ^{3, 10}
System torque	Nm	–	–	–	–	–	–	420 ¹⁰

Lithium-ion high-voltage battery								
Battery type/net battery capacity	kWh	–	–	–	–	–	–	– ¹⁰
Electric range/Maximum total range, combined ⁴	km	–	–	–	–	–	–	up to 63 ¹⁰
Charging time (0–80%)/(0–100%) ⁵	h	–	–	–	–	–	–	– ¹⁰

Power transmission								
Type of drive (xDrive)	–	Rear-wheel ¹⁰	Rear-wheel (all-wheel)	(all-wheel)	Rear-wheel ¹⁰	Rear-wheel (all-wheel)	Rear-wheel ¹⁰ (all-wheel)	Rear-wheel ¹⁰
Standard transmission (xDrive)	–	(8-speed Steptronic) ¹⁰	8-speed Steptronic	(8-speed Steptronic Sport) ¹⁰	6-speed manual ¹⁰ (8-speed Steptronic) ¹⁰	6-speed manual (8-speed Steptronic)	8-speed Steptronic ¹⁰ (8-speed Steptronic)	– ¹⁰

Driving performance								
Top speed (xDrive)	km/h	[230]	[250] ⁸ ([250]) ⁸	[(250)] ^{8, 10}	216 ¹⁰ [214] ¹⁰	229 [230] ([225])	[250] ^{8, 10} ([250]) ⁸	220 ¹⁰
Top electric speed	km/h	–	–	–	–	–	–	– ¹⁰
Acceleration 0–100 km/h (xDrive)	s	[7.6] ¹⁰	[5.9] [5.8]	[(4.5)] ¹⁰	8.9 [8.8] ¹⁰	7.5 [7.1] ([7.4])	[5.6] ¹⁰ [(5.4)]	6.1 ¹⁰

Consumption ^{3, 6} – All engines conform to the EU6 standard								
Urban (xDrive)	l/100 km	– ¹⁰	[7.7–7.3] ([7.9–7.6])	– ¹⁰	– ¹⁰	5.5–5.4 [5.3–4.8] ([5.4–5.2])	– ¹⁰ ([6.5–6.4])	– ¹⁰
Extra-urban (xDrive)	l/100 km	– ¹⁰	[5.7–5.2] ([5.9–5.5])	– ¹⁰	– ¹⁰	4.4–4.0 [4.5–4.2] ([4.7–4.3])	– ¹⁰ ([5.1–4.7])	– ¹⁰
Combined (xDrive)	l/100 km	[6.3–5.8] ¹⁰	[6.4–6.0] ([6.6–6.3])	[7.5–7.1] ¹⁰	4.9–4.5 [4.7–4.3]	4.8–4.6 [4.8–4.4] ([4.9–4.6])	[5.5–5.2] ¹⁰ ([5.6–5.4])	2.3–1.8 ¹⁰
Consumption range, combined ⁷	kWh/100 km	–	–	– ¹⁰	– ¹⁰	–	–	16.3–15.7 ¹⁰
Exhaust emissions standard (type-certified)	–	– ¹⁰	EU6d-Temp	– ¹⁰	– ¹⁰	EU6d-Temp	EU6d-Temp	– ¹⁰
Combined CO ₂ emissions (xDrive)	g/km	[144–133] ¹⁰	[146–136] ([151–143])	[(170–162)]	129–118 [125–114] [125–114] ¹⁰	125–119 [125–115] ([129–121])	[144–135] ¹⁰ ([146–140])	52–42 ¹⁰
Tank capacity, approx.	l	– ¹⁰	59	– ¹⁰	– ¹⁰	40/59 ¹³	59	– ¹⁰

Wheels/tyres								
Tyre dimensions	– ¹⁰	– ¹⁰	225/50 R17 98 YXL	– ¹⁰	– ¹⁰	225/50 R17 98 YXL	225/50 R17 98 YXL	– ¹⁰
Wheel size	– ¹⁰	– ¹⁰	7.5 J x 17	– ¹⁰	– ¹⁰	7.5 J x 17	7.5 J x 17	– ¹⁰
Material	– ¹⁰	– ¹⁰	Light alloy	– ¹⁰	– ¹⁰	Light alloy	Light alloy	– ¹⁰

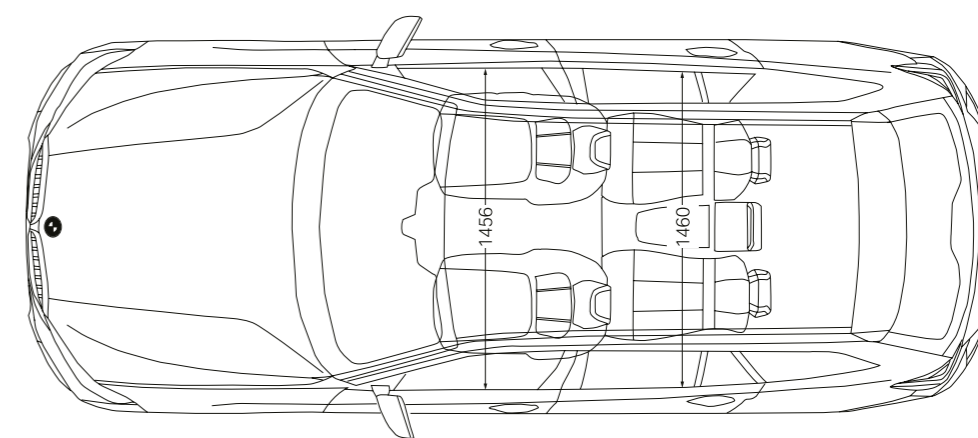
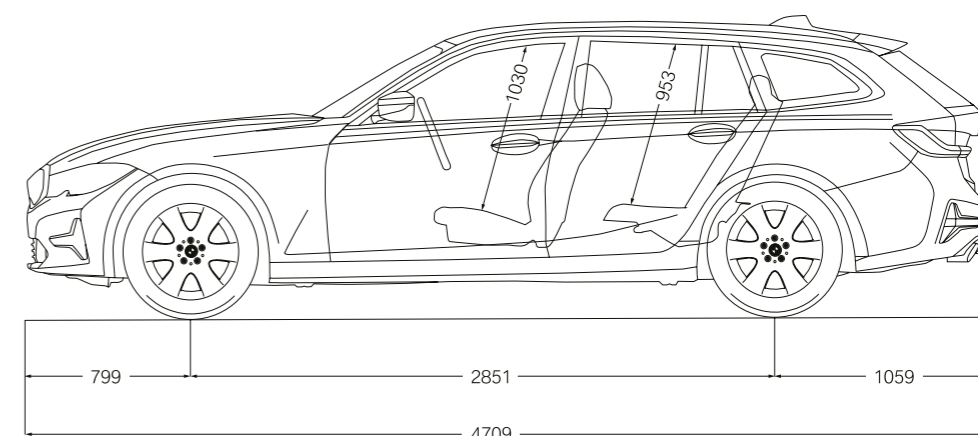
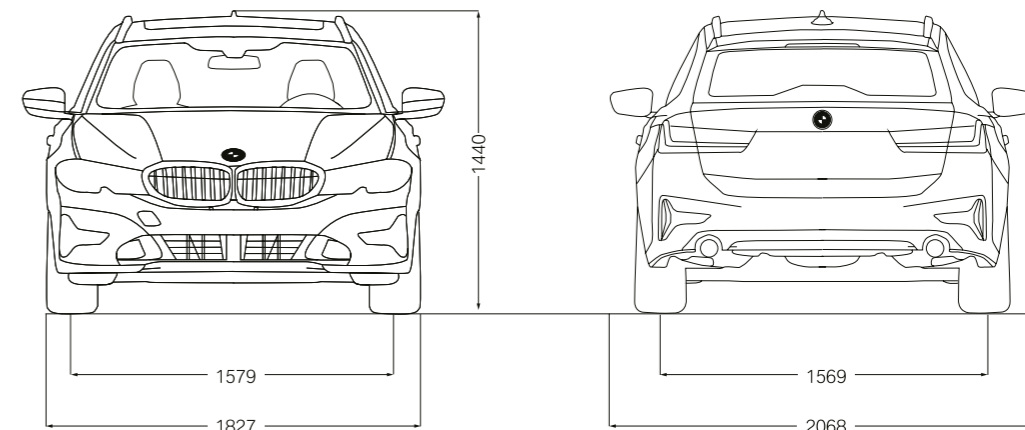

The figures for performance, fuel consumption and CO₂ emissions refer to vehicles with standard transmission. Figures in [] are for vehicles with Steptronic transmission.

¹ The EC unladen weight refers to a vehicle with standard equipment and does not include any optional extras. The unladen weight includes a 90% full tank and a driver weight of 75 kg. Optional equipment may affect the weight of the vehicle, the payload and the top speed if the selected equipment has an impact on the vehicle's aerodynamics.

² The actual total weight of the trailer must not exceed the maximum trailer load, taking into account the maximum tow bar download.

³ Performance data of petrol engines apply to vehicles using RON 98 fuel. Fuel consumption data apply to vehicles using reference fuels in accordance with EU Regulation 2007/15. Unleaded RON 91 and higher with a maximum ethanol content of 10% (E10) may also be used. BMW recommends RON 95 super unleaded petrol.

⁴ Range depends on various factors. In particular: personal driving style, route characteristics, exterior temperature, heating/air conditioning, pre-conditioning.

⁵ Dependent on the local electricity infrastructure. Charging time corresponds to a 100% charge of maximum capacity.

⁶ The data for fuel consumption, CO₂ emissions and energy consumption are determined in accordance with the measurements processes as defined by European Regulation (EU) 2007/15 in the applicable version. Data refer to a vehicle with base-level equipment in Germany, and the ranges account for differences according to the selected wheel and tyre size and the optional equipment and may change during the configuration process. Figures have been determined on the basis of the new WLTP test cycle and have been converted back into NEDC figures for comparability. [For these vehicles, values other than those specified here may apply for the assessment of taxes and other vehicle-related charges that are (also) based on CO₂ emissions].

⁷ The combined energy consumption depends on the selected wheel and tyre sizes.

⁸ Electronically limited.

⁹ 135 kW combustion engine + up to 83 kW electric drive.

¹⁰ Provisional figures.

¹¹ Planned availability: 11/2019.

¹² Planned availability: 07/2020.

¹³ Optionally available.

BMW 330i TOURING WITH M SPORT PACKAGE:

BMW TwinPower Turbo 4-cylinder petrol engine, 190 kW (258 hp), 19" BMW Individual light alloy wheels Double-spoke style 793 I Bicolour with mixed tyres, exterior colour in Dravite Grey metallic, Sport seats for driver and front passenger in leather 'Vernasca' Oyster decor stitching, fine-wood trim oak grain open-pored.

The models illustrated in this brochure show the equipment and configuration options (standard and optional) for vehicles produced by BMW AG for the German market. Alterations in standard and optional equipment and the configurations available for the different models, as described in this brochure, may occur after 29/04/2019, the date when this brochure went to press, or according to the specific requirements of other markets. Your local BMW Partner is available to provide further details. Subject to change in design and equipment.

© BMW AG, Munich, Germany. Not to be reproduced wholly or in part without prior written permission of BMW AG, Munich.
411 003 123 20 1 2019 CB. Printed in Germany 2019.